

STENOX[®]



2026 Product Catalog

PAINT & METAL SELECTION

Backed By Senox's 50 Year Paint Warranty

TRADITIONAL PAINTED ALUMINUM

Factory Baked Finish • Flexible for Roll Forming • Exterior Durability



001 - 30° White



002 - Royal Brown



003 - Antique Ivory



004 - Black



005 - Raffia Beige



006 - Beaver Brown



007 - Classic Cream



008 - Clay



009 - Colonial Blue



010 - Sherwood Green



011 - Musket Brown



013 - Wicker



014 - Dove Gray



015 - Almond



017 - Linen



018 - Light Bronze



019 - Tuxedo Gray



020 - Heritage Cream



021 - Colonial Gray



022 - Buckskin Brown



023 - 80° White



024 - Colonial Red



025 - Dark Bronze



026 - Herringbone

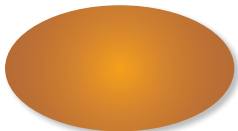

027 - Copper Metallic



028 - Paint Grip Metallic

Colors shown may vary from actual material

ArmerTOUGH PAINTED ALUMINUM

Exclusive Product • Abrasion Resistant • Reduces Appearance of Staining



130 - Satin White

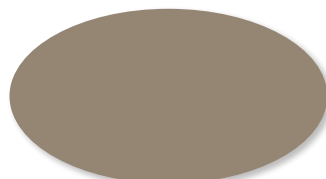

131 - Wood Beige



132 - Cameo

DuelTone® PAINTED ALUMINUM

Created Through a Specialized Two-Coat Process
High Performance Exterior Finish



129 - Rustic Copper

PREMIUM METALS

3/4 Hard 16 oz. Copper
Galvalume Plus Steel

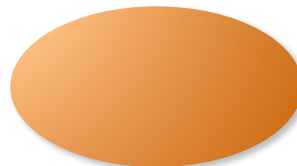

890 - Solid Copper



920 - Galvalume Plus Steel

ShadowBAK
wash coat®
Non-Reflective Disappearing Wash Coat

Found on the Interior of Senox Painted Aluminum Gutters

ShadowBAK® is a washcoat specially formulated by Senox that gives the inside of the gutter a non-reflective finish. The anodized bronze appearance provides the vanishing properties of a black shadow and erases the transition lines from the gutter to the roof.

TABLE OF CONTENTS

BRANCH LOCATIONS Senox Branches	p.3	FASTENERS Rivets #42 x 1/8" #8 Screws Senox SpeedMaster™ Screws Nails, Drive Pins, & Anchors	p.19
COIL Seamless Gutter Coil	p.4	PAINT & SEALANT Touch-Up Paint Sealant - Nitrile Rubber Base Sealant - Tripolymer Base Sealant - SBR Rubber Base	p.20
GUTTER End Caps for K-Style Miters for K-Style Outlets for Flat Bottom Gutter Black MAX® Punch Paks for Flat Bottom Gutter Black MAX® Mini Punch Paks for Flat Bottom Gutter Black MAX® Punch Replacement Accessories	p.4 p.5	TOOLS Aviation Snips Offset Snips Regular Pattern Snips Straight Snips Circular "Duckbill" Snips Combination Snips End Cap Crimpers	p.21
Flashing 16 oz. Solid Copper Flat Sheets Gutter Bumpers for K-Style	p.6	Downspout Crimpers Hand Seamers Drivers, Leveling & Caulking	p.22
DOWNSPOUT Rectangular Downspouts Rectangular Elbows Rectangular Offsets 3X4 Smooth Downspouts 3X4 Smooth Elbows	p.7 p.8	Cutting & Drilling Ladder Accessories Miscellaneous Accessories Joints	p.23
Round Downspouts Round Elbows Round Offsets	p.9	RAIN CHAINS Rain Chains	p.24
Downspout Accessories Downspout Hangers	p.10	CONDUCTOR HEADS Conductor Heads	p.25
K-STYLE HANGERS K-Style Internal Hangers	p.11	GUTTER MACHINES Complete Boxer GutterSystem 6" Boxer Machines Downspouts & Elbows (for Boxer)	p.26
HALF ROUND GUTTER Reverse Bead Half Round Internal Hangers Half Round External Hangers Reverse Bead Half Round Gutter Sections End Caps for Half Round Miters for Half Round Outlets for Half Round Black MAX® Mini Punch Pak for Half Round Gutter Wedges for Reverse Bead Half Round	p.14 p.15	Endcaps (for Boxer) AqueDUCT® Screen hangers (for Boxer) AqueDUCT® Miters (for Boxer) BearCLAW® Hangers (for Boxer) BearCLAW® Gutter Guard (for Boxer)	p.27
GUTTER GUARDS Aluminum Expanded Wire Gutter Guard Powder Coated Expanded Wire Gutter Guard Perforated Gutter Guard Stainless Steel Metal Mesh Gutter Guard Louvered Gutter Guard Solid Gutter Guard	p.16 p.17	6.5" Half Round Wedger Gutter Machines AqueDUCT® Screen hangers (for HR) AqueDUCT® Miters (for HR) BearCLAW® Hangers (for HR) BearCLAW® Gutter Guard (for HR)	p.28
DRAINAGE Splash blocks FLEX-Drain® Underground Drainage & Adaptors Universal Drainage & Adaptors	p.18	Barracuda® Gutter Machines Barracuda® Gutter Machine Options	p.29
		INDEX	p.31
		JOB ESTIMATE FORM	p.32



Serving the Seamless Gutter Industry Since 1972

LARGEST INVENTORY IN-STOCK

- Complete 5" & 6" K-Style and 6" Half Round product lines
- Dependable order fulfillment & delivery

COMPREHENSIVE COLOR SELECTION

- 26 Painted aluminum colors, galvalume plus steel, & solid copper
- 3 Exclusive Armor Tough® painted aluminum colors
- Exclusive Duel Tone painted aluminum color
- All backed by Senox's 50 year paint warranty

GUTTER ACCESSORIES

- Hidden hangers and half round internal & external hangers
- Outlets, offsets, miters, conductor heads, & more

HIGHEST QUALITY PRODUCTS

- State-of-the-art manufacturing equipment ensures products are of the highest quality
- Senox manufactured products are made in North America

SUPERIOR PACKAGING

- High grade cardboard used for all boxes
- Packaging specific to each product, no excess space for product to shift
- Boxes are sealed using staples vs. tape

GUTTER MACHINES

- Comprehensive gutter machine service
- 3 Year parts & 1 year electrical warranty on all Senox gutter machines

"We service the seamless gutter industry. That's all we do. If it has to do with gutters, we're either doing it, thinking about doing it, or planning to do it. We're thinking about gutters all the time."

—A.B. Walters
Founder & President



SENOX BRANCH LOCATIONS

E-COMMERCE

www.SenoxOnline.com
Ph: 800-722-6958
Fax: 888-804-4035

AUSTIN

12112 Boardwalk Dr. Ste B
Austin, TX 78729
Ph: 512-582-1331
Fax: 512-582-1333
Rep: Mike Morales
512-673-0921

CORPUS CHRISTI

2334 Pollex Ave
Corpus Christi, TX 78415
Ph: 361-270-0045
Rep: Sal Garza
713-823-9289

DALLAS

3236 Garden Brook St.
Farmers Branch, TX 75234
Ph: 972-243-7272
Fax: 972-243-7273
Rep: Jeremiah Locke
972-213-6843

FORT WORTH

5204-D Airport Fwy.
Fort Worth, TX 76117
Ph: 817-831-4900
Fax: 817-831-4901
Rep: Jeremiah Locke
972-213-6843

GARLAND

3301 Wood Dr Ste 400
Garland, TX 75041
Ph: 469-573-2233
Fax: 469-573-2204
Rep: Jeremiah Locke
972-213-6843

HOUSTON CENTRAL

4466 W 12th St.
Houston, TX 77055
Ph: 713-316-9802
Fax: 713-316-9807
Rep: Sal Garza
713-823-9289

HOUSTON NORTH

11103 Bellline Rd. #100
Houston, TX 77067
Ph: 281-443-0420
Fax: 281-443-0490
Rep: Sal Garza
713-823-9289

LONGVIEW

413 S. Eastman Rd.
Longview, TX 75602
Ph: 903-295-9555
Fax: 903-295-9797
Rep: Rick Coffelt
972-896-6834

LUBBOCK

8911 County Rd 6830
Lubbock, TX 79407
Ph: 806-516-1079
Rep: Troy Rose
239-990-7002

OKLAHOMA CITY

1340 Metropolitan Ave.
Oklahoma City, OK 73108
Ph: 405-948-7464
Fax: 405-948-6287
Rep: Rick Coffelt
972-896-6834

SAN ANTONIO

3816 Binz-Engelman Rd.
B-111
San Antonio, TX 78218
Ph: 210-514-1173
Fax: 210-514-1175
Rep: Michael Ponce
210-906-1230

CHATTANOOGA

3475-C 8th Ave.
Chattanooga, TN 37407
Ph: 423-698-0050
Fax: 423-698-3146
Rep: Jason Harris
423-443-7814

FULTON

555-C Wharton Circle
Atlanta, GA 30336
Ph: 404-691-9400
Fax: 404-691-0094
Rep: Sam Henley
404-423-1928

KENNESAW

3690 Kennesaw S. Ind. Dr.
Kennesaw, GA 30144
Ph: 770-795-8500
Fax: 770-795-9991
Rep: Sam Henley
404-423-1928

NASHVILLE

302 Space Park Dr. S.
Nashville, TN 37211
Ph: 615-333-3383
Fax: 615-333-3374
Rep: Rob Vail
615-653-6941

SUWANEE

2970 Shawnee Ridge Ct.
#200
Suwanee, GA 30024
Ph: 770-476-4141
Fax: 770-476-4175
Rep: Sam Henley
404-423-1928

TUCKER

4662 North Royal Atlanta Dr.
Tucker, GA 30084
Ph: 404-292-6181
Fax: 404-292-6521
Rep: Sam Henley
404-423-1928

DEERFIELD BEACH

740 S Powerline Rd. Ste H
Deerfield Beach, FL 33442
Ph: 954-418-7003
Rep: Troy Rose
239-990-7002

FORT MYERS

6361 Topaz Court
Fort Meyers, FL 33966
Ph: 239-217-6303
Fax: 239-217-3513
Rep: Troy Rose
239-990-7002

JACKSONVILLE

6858 Phillips Parkway Dr. S.
Jacksonville, FL 32256
Ph: 904-880-2192
Fax: 904-880-7256
Rep: John Perez
813-734-4428

ORLANDO

7473 Presidents Dr.
Orlando, Florida 32809
Ph: 407-734-2148
Fax: 407-369-4229
Rep: John Perez
813-734-4428

PENSACOLA

3855 N Palafox St
Pensacola, FL 32505
Ph: 850-701-8192
Fax: 850-303-2682
Rep: Troy Rose
239-990-7002

TAMPA

201-C Kelsey Ln.
Tampa, Florida 33619
Ph: 813-623-6178
Fax: 813-626-1306
Rep: John Perez
813-734-4428

CHARLOTTE

3500 Woodpark Blvd Ste G
Charlotte, NC 28206
Ph: 704-371-5043
Fax: 704-371-5077
Rep: Rob Vail
615-653-6941

SENOX®

SEAMLESS GUTTER COIL

Senox seamless gutter coil is available in painted aluminum (all 26 traditional Senox colors), copper, or galvalume+ (all painted coil comes backed by our 50 year paint warranty.)

11 7/8"
 .027" Aluminum
 part # 1111950XXX

15"
 .027" Aluminum
 part # 1115050XXX

Available in: 26 Traditional, 1 Duel Tone®, 3 Armor Tough®

11 7/8"
 .032" Aluminum
 part # 11119710XXX

15"
 .032" Aluminum
 part # 11150710XXX

Available in: 26 Traditional, 1 Duel Tone®, 3 Armor Tough®

11 7/8"
 16 oz. Solid Copper
 part # 1111951890

15"
 16 oz. Solid Copper
 part # 1115051890

Galvalume Plus Steel
 part # 1111950920

Galvalume Plus Steel
 part # 1115050920

18"
 .032" Aluminum
 part # 11180710XXX

18"
 16 oz. Solid Copper
 part # 1118051890

Galvalume Plus Steel
 part # 1118050920



END CAPS FOR K-STYLE

Packaged 25R/25L Pcs/Box

Senox end caps provide a tap on fit to easily close the ends of the gutter; uses painted Senox coil to ensure a perfect match every time.

5" Right or Left
 right - part # 2215030XXX
 left - part # 2215050XXX

6" Right or Left
 right - part # 2216030XXX
 left - part # 2216050XXX

7" Right or Left
 right - part # 2217030XXX
 left - part # 2217050XXX

Available in: 26 Traditional, 1 Duel Tone® (129), 3 Armor Tough®, 16 oz. Solid Copper (890), Galvalume Plus Steel (920)



MITERS FOR K-STYLE

Packaged 20 pcs/Box

The fastest way to install corners, and available in the full range of Senox colors to perfectly match Senox gutters.

5", 90°, Strip, O/S or I/S
 O/S - part # 2315110XXX
 I/S - part # 2315130XXX

6", 90°, Strip, O/S or I/S
 O/S - part # 2316110XXX
 I/S - part # 2316130XXX

7", 90°, Strip, O/S or I/S
 O/S - part # 2317110XXX
 I/S - part # 2317130XXX

5", 45°, Bay, O/S or I/S
 O/S - part # 2315310XXX
 I/S - part # 2315330XXX

6", 45°, Bay, O/S or I/S
 O/S - part # 2316310XXX
 I/S - part # 2316330XXX

7", 45°, Bay, O/S or I/S
 O/S - part # 2317310XXX
 I/S - part # 2317330XXX

5", 90°, Box, O/S or I/S
 O/S - part # 2315610XXX
 I/S - part # 2315630XXX

6", 90°, Box, O/S or I/S
 O/S - part # 2316610XXX
 I/S - part # 2316630XXX

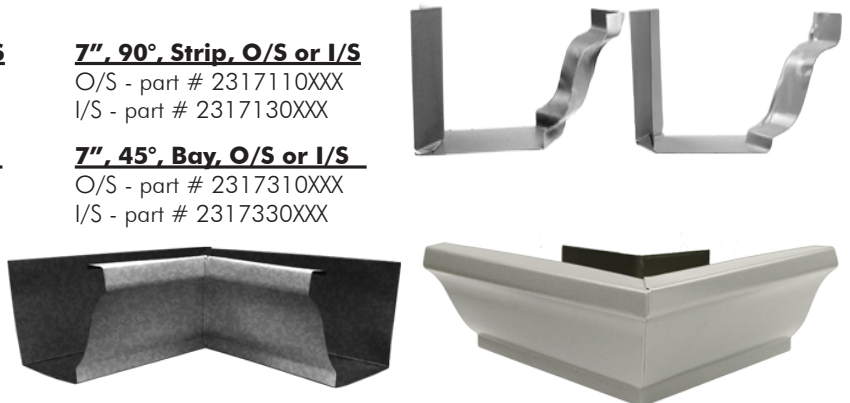

Available in: 26 Traditional, 1 Duel Tone®, 3 Armor Tough®, 16 oz. Solid Copper (890), Galvalume Plus Steel (920)

COLOR SELECTION

Traditional Painted Aluminum

- 001 30° White
- 002 Royal Brown
- 003 Antique Ivory
- 004 Black
- 005 Raffia Beige
- 006 Beaver Brown
- 007 Classic Cream
- 008 Clay
- 009 Colonial Blue
- 010 Sherwood Green
- 011 Musket Brown
- 013 Wicker
- 014 Dove Gray
- 015 Almond
- 017 Linen
- 018 Light Bronze
- 019 Tuxedo Gray
- 020 Heritage Cream

- 021 Colonial Gray
- 022 Buckskin Brown
- 023 80° White
- 024 Colonial Red
- 025 Dark Bronze
- 026 Herringbone
- 027 Copper Metallic
- 028 Paint Grip Metallic

Duel Tone® Painted Aluminum

- 129 Rustic Copper

Armor Tough® Painted Aluminum

- 130 Satin White
- 131 Wood Beige
- 132 Cameo

Metal Selection

- 099 Mill Finish Aluminum
- 870 Brass
- 890 Solid Copper
- 910 Galvanized Steel
- 920 Galvalume Plus Steel

OUTLETS FOR FLAT BOTTOM GUTTER

Senox outlets include an exclusive dimple for easy 'pop in' installation when used in tandem with our outlet punch- helps provide a snug fit when installing the outlet in the bottom of the gutter.

2 3/8" Round
250 pcs/box
part # 2612110004



Available in: Black (004)

2 3/4" Round
250 pcs/box
part # 2613110004



Available in: Black (004)

3" Oval
100 pcs/box
part # 263311XXXX



4" Oval
50 pcs/box
part # 263411XXXX



Available in: Black (004), Solid Copper (890), Galvanized Steel (910)

2" x 3" Rectangle
100 pcs/box
part # 2643110004



Available in: Black (004)

3" x 4" Rectangle
50 pcs/box
part # 2644120004



Available in: Black (004)

4" x 5" Rectangle
50 pcs/box
part # 2645140XXX



Available in: Aluminum (099), Solid Copper (890), Galvanized Steel (910)

BLACK MAX® PUNCH PAKS FOR FLAT BOTTOM GUTTER

Everything you need to install the best gutter outlets anywhere; the Punch Pak includes Punch, 1 1/2" Hole Saw, 1/4" Driver Power Bit, and outlets- all for the same price as just ordering the outlets by themselves!

2 3/8" Round
750 Outlets
part # 2612119004

2 3/4" Round
750 Outlets
part # 2613119004

2" x 3" Rectangle
900 Outlets
part # 2643119004

3" Oval
900 Outlets
part # 2633119004

4" Oval
450 Outlets
part # 2634119004

3" x 4" Rectangle
450 pcs/box
part # 2644129004

Includes: Punch, 1 1/2" Hole Saw, 1/4" Driver Power Bit, Outlets



BLACK MAX® MINI PUNCH PAKS FOR FLAT BOTTOM GUTTER

If you're just doing a job or two and don't need as many outlets as our standard Punch Pak, you need the Mini Punch Pak. Includes Punch, 1 1/2" Hole Saw, 1/4" Driver Power Bit, and outlets.

2 3/8" Round
35 Outlets
part # 2612118004

2 3/4" Round
35 Outlets
part # 2613118004

2" x 3" Rectangle
100 Outlets
part # 2643118004

3" Oval
100 Outlets
part # 2633118004

4" Oval
50 Outlets
part # 2634118004

3" x 4" Rectangle
50 pcs/box
part # 2644128004

Includes: Punch, 1 1/2" Hole Saw, 1/4" Driver Power Bit, Outlets



BLACK MAX® PUNCH REPLACEMENT ACCESSORIES

Hole Saw 1 1/2", for Punch
part # 8926928



Driver Bit 1/4", for Punch
part # 8950812



FLASHING

No fasteners needed; Senox Drip Caps help keep water from running behind the gutter, protecting your customer's roof.

Senox Drip Edges have the largest color selection in the marketplace today- available in all Senox colors.

Drip Cap

30 pcs/box
4' - part # 291812XXX

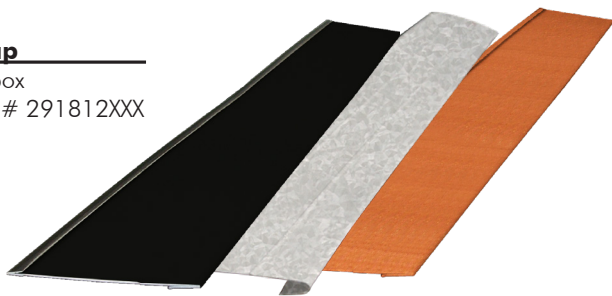

Drip Edge, 1 1/2" x 1 1/2"

30 pcs/box - Aluminum
15 pcs/box - Copper, Steel
10' - part # 2910150XXX

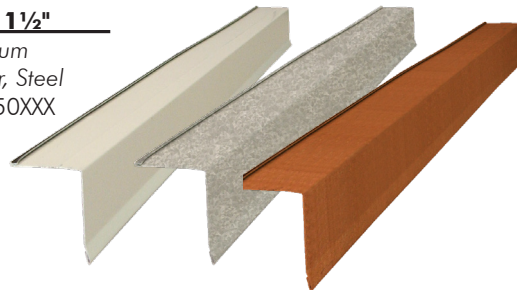

Available in: Black (004), 16 oz. Solid Copper (890), Galvalume Plus Steel (920)

Available in: 26 Traditional, 1 Duel Tone®(129), 3 Armor Tough®, 16 oz. Solid Copper (890), Galvalume Plus Steel (920)

16 OZ. SOLID COPPER FLAT SHEETS

3' x 10'

36 pcs/pallet
part # 133655890



GUTTER BUMPERS FOR K-STYLE

Compared to traditional gutter wedges, Senox Gutter Bumpers are faster & more cost effective- and with premarked lines, cutting accurately is easier than ever. All our bumpers feature ribs to provide extra strength and the SB bumper also fits 5", 6", & 7" K-Style gutters, unlike traditional wedges which you buy to size.

Gutter Bumper® SB

100 pcs/box
part # 2928150XXX

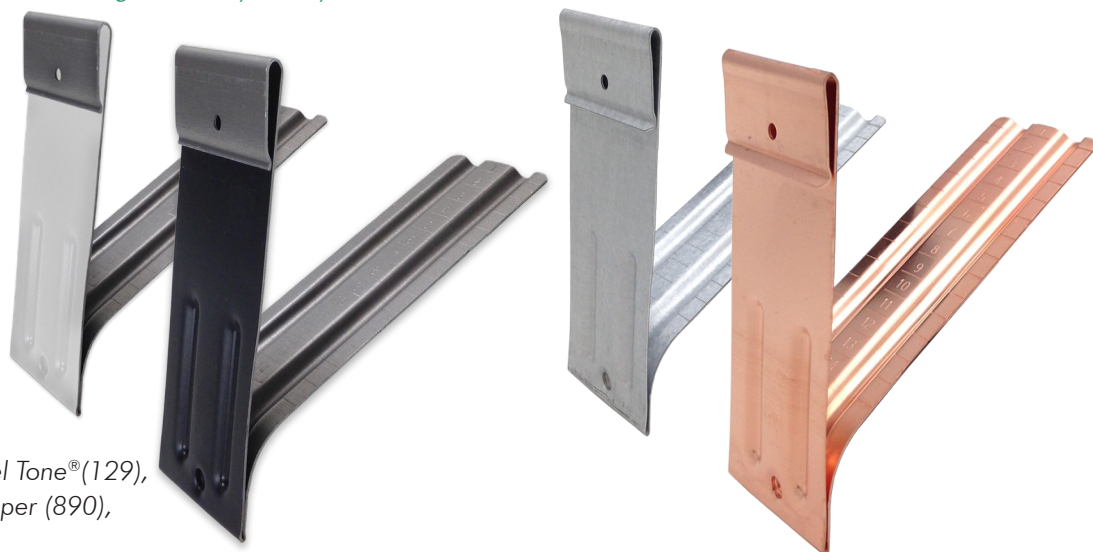

Available in: 26 Traditional, 1 Duel Tone®(129), 3 Armor Tough®, 16 oz. Solid Copper (890), Galvalume Plus Steel (920)

For Straight Back Gutter

RECTANGULAR DOWNPOUTS

Senox rectangular downspouts feature side crimp instead of the usual corner crimp, which allows for a cleaner transition.

2" x 3" x 8'

10 pcs/box
part # 4143240XXX

3" x 4" x 8'

10 pcs/box
part # 4144240XXX

Available in: 26 Traditional, 1 Duel Tone®, 3 Armor Tough®

2" x 3" x 10'

10 pcs/box - Aluminum
5 pcs/box - Copper & Steel
part # 4143250XXX

3" x 4" x 10'

10 pcs/box - Aluminum
5 pcs/box - Copper & Steel
part # 4144250XXX

4" x 5" x 10'

6 pcs/box
part # 4145250XXX



Available in: 26 Traditional, 1 Duel Tone® (129), 3 Armor Tough®, 16 oz. Solid Copper (890), Galvalume Plus Steel (920)

RECTANGULAR ELBOWS

2" x 3", A or B, 75°

36 pcs/box
A - part # 4243270XXX
B - part # 4243770XXX

3" x 4", A or B, 75°

20 pcs/box
A - part # 4244270XXX
B - part # 4244770XXX

4" x 5", A or B, 75°

12 pcs/box
A - part # 4245270XXX
B - part # 4245770XXX



2" x 3", A, 22.5°

72 pcs/box
part # 42432200XXX

3" x 4", A, 22.5°

40 pcs/box
part # 42442200XXX

4" x 5", A, 22.5°

12 pcs/box
part # 42452200XXX

2" x 3", A, 45°

42 pcs/box
part # 42432400XXX

3" x 4", A, 45°

30 pcs/box
part # 42442400XXX

4" x 5", A, 45°

12 pcs/box
part # 42452400XXX



Available in: 26 Traditional, 1 Duel Tone® (129), 3 Armor Tough®, 16 oz. Solid Copper (890), Galvalume Plus Steel (920)

RECTANGULAR OFFSETS

2" x 3" x 2"

24 pcs/box
part # 4343220XXX

2" x 3" x 4"

24 pcs/box
part # 4343240XXX

2" x 3" x 6"

24 pcs/box
part # 4343260XXX

3" x 4" x 2"

15 pcs/box
part # 4344220XXX

3" x 4" x 4"

15 pcs/box
part # 4344240XXX

3" x 4" x 6"

15 pcs/box
part # 4344260XXX



Available in: 26 Traditional, 1 Duel Tone® (129), 3 Armor Tough®, 16 oz. Solid Copper (890), Galvalume Plus Steel (920)

MADE TO ORDER

If you need a less common bend, we've got you covered!
Custom bend elbows are available upon request.

2" x 3", A or B, 90°

36 pcs/box
A - part # 424329XXX
B - part # 424379XXX

3" x 4", A or B, 90°

18 pcs/box
A - part # 424429XXX
B - part # 424479XXX

2" x 3", B, 45°

42 pcs/box
part # 424374XXX

3" x 4", B, 45°

25 pcs/box
part # 424474XXX



Available in: 26 Traditional, 1 Duel Tone® (129), 3 Armor Tough®, 16 oz. Solid Copper (890), Galvalume Plus Steel (920)

*some conditions apply, talk to your Rep for more details

3" X 4" SMOOTH DOWNPOUTS

Packaged 5 Pcs/Box

Available in every Senox color, Senox 3 x 4 smooth downspouts are the perfect compliment to our Boxer gutters (and offer a different option for K-Style gutters, too!)

10' Downspout

5 pcs/box

All colors

Part # 413425xxx

Available in: 26 Traditional, 1 Duel Tone® (129), 3 Armor Tough®, 16 oz. Solid Copper (890), Galvalume Plus Steel (920)



3" X 4" SMOOTH ELBOWS

22.5° 'A' Elbows

25 pcs/box

All colors

Part # 423422XXX

Available in: 26 Traditional, 1 Duel Tone® (129), 3 Armor Tough®, 16 oz. Solid Copper (890), Galvalume Plus Steel (920)



45° 'A' Elbows

20 pcs/box

All colors

Part #423424XXX

Available in: 26 Traditional, 1 Duel Tone® (129), 3 Armor Tough®, 16 oz. Solid Copper (890), Galvalume Plus Steel (920)



75° 'A' Elbows

15 pcs/box

All colors

Part #4234270XXX

Available in: 26 Traditional, 1 Duel Tone® (129), 3 Armor Tough®, 16 oz. Solid Copper (890), Galvalume Plus Steel (920)



75° 'B' Elbows

15 pcs/box

All colors

Part #4234770XXX

Available in: 26 Traditional, 1 Duel Tone® (129), 3 Armor Tough®, 16 oz. Solid Copper (890), Galvalume Plus Steel (920)



ROUND DOWNSPOUTS

Packaged 5 Pcs/Box

Available in every Senox color, Senox round downspouts are the perfect compliment to our Half Round gutters (and offer a different option for K-Style gutters, too!)

3" x 10' Round

5 pcs/box
part # 4153250XXX

4" x 10' Round

5 pcs/box
part # 4154250XXX

Available in: 26 Traditional, 1 Duel Tone® (129), 3 Armor Tough®, 16 oz. Solid Copper (890), Galvalume Plus (920)

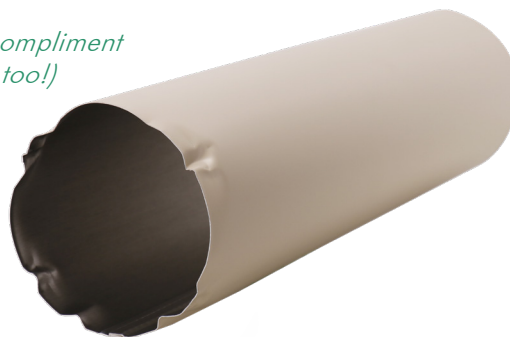

ROUND ELBOWS

3" Round, 75°

10 pcs/box
part # 4253270XXX

3" Round, 45°

12 pcs/box
part # 4253240XXX

4" Round, 22.5°

12 pcs/box
part # 4254220XXX

3" Round, 22.5°

12 pcs/box
part # 4253220XXX

4" Round, 75°

10 pcs/box
part # 4254270XXX

4" Round, 45°

10 pcs/box
part # 4254240XXX

Available in: 26 Traditional, 1 Duel Tone®, 3 Armor Tough®, 16 oz. Solid Copper, Galvalume Plus Steel



22.5°



45°



75°

MADE TO ORDER

If you need a round elbow in a color not shown, we can do that! Custom round elbows are available upon request!*

3" Round, 90°

8 pcs/box
part # 4253290XXX

4" Round, 90°

8 pcs/box
part # 4254290XXX

Available in: 26 Traditional, 1 Duel Tone® (129), 3 Armor Tough®, 16 oz. Solid Copper (890), Galvalume Plus Steel (920)

*some conditions apply, talk to your Rep for more details

ROUND OFFSETS

3" Round x 2"

6 pcs/box
part # 4353220XXX

3" Round x 4"

6 pcs/box
part # 4353240XXX

3" Round x 6"

4 pcs/box
part # 4353260XXX

4" Round x 2"

4 pcs/box
part # 4354220XXX

4" Round x 4"

4 pcs/box
part # 4354240XXX

4" Round x 6"

4 pcs/box
part # 4354260XXX

Available in: 26 Traditional, 1 Duel Tone® (129), 3 Armor Tough®, 16 oz. Solid Copper (890), Galvalume Plus Steel (920)



DOWNSPOUT ACCESSORIES

Scupper

1 pcs/box
part # 496770001

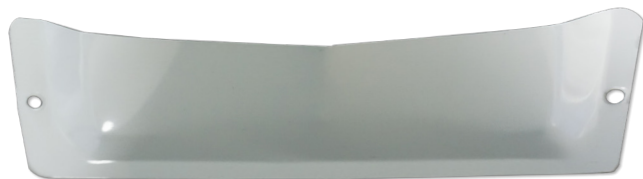

DOWNSPOUT HANGERS/PIPEBANDS

Available in all Senox colors, Quarter Moon hangers give a decorative finish to your downspout installations.

Quarter Moon for Rectangular

For 2"X3" and 3"X4"
100 pcs/box
part # 4540650XXX



Quarter Moon for Round

For 3" and 4"
100 pcs/box
part # 4541650XXX



Available in: 26 Traditional, 1 Duel Tone® (129), 3 Armor Tough®, 16 oz. Solid Copper (890), Galvalume Plus Steel (920)

Concealed for Rectangular

For 2"X3" and 3"X4"
100 pcs/box
part # 4535550XXX

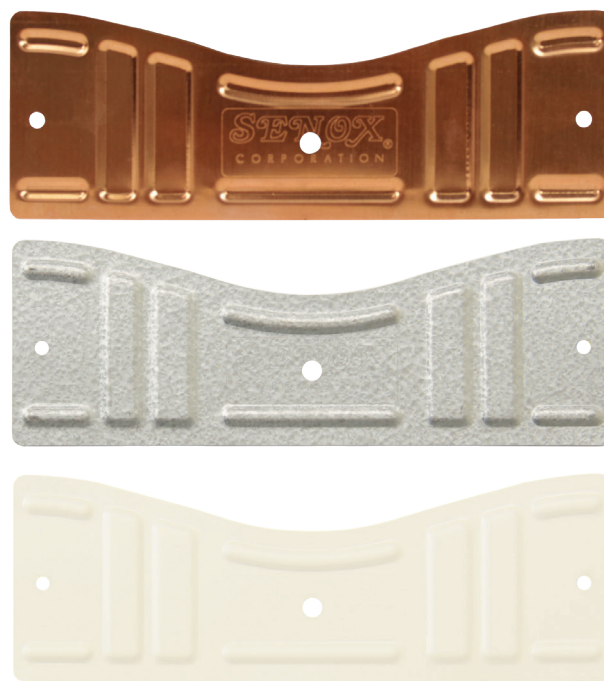

Available in: 26 Traditional, 1 Duel Tone® (129), 3 Armor Tough®, 16 oz. Solid Copper (890), Galvalume Plus Steel (920)

K-STYLE INTERNAL HANGERS

1600 Series for 5", 6"

Aluminum .060 with or without clip

Our most economical .060 robust hanger (but still built to Senox's high standards)

100 pcs/box - Aluminum

5", no clip - part # 2416501099

5", w/clip - part # 2416531099

6", no clip - part # 2416601099

6", w/clip - part # 2416631099

Mini-barrels - Aluminum

5", no clip - 1000 pcs - part # 2416504099

5", w/clip - 1000 pcs - part # 2416534099

6", no clip - 500 pcs - part # 2416603099

6", w/clip - 500 pcs - part # 2416633099

1800 Series for 5", 6"

Aluminum .047 with or without clip

The most cost efficient way to eliminate gutter rattle

100 pcs/box - Aluminum

5", no clip - part # 2418501099

5", w/clip - part # 2418531099

6", no clip - part # 2418601099

6", w/clip - part # 2418631099

Mini-barrels - Aluminum

5", no clip - 1000 pcs - part # 2418504099

5", w/clip - 1000 pcs - part # 2418534099

6", no clip - 500 pcs - part # 2418603099

6", w/clip - 500 pcs - part # 2418633099

2100 Series for 5", 6"

Aluminum .060 with or without clip

Our top seller! Senox's strongest hanger to come without a pre-loaded screw.

100 pcs/box - Aluminum

5", no clip - part # 2421501099

5", w/clip - part # 2421531099

6", no clip - part # 2421601099

6", w/clip - part # 2421631099

Mini-barrels - Aluminum

5", no clip - 1000 pcs - part # 2421504099

5", w/clip - 1000 pcs - part # 2421534099

6", no clip - 500 pcs - part # 2421603099

6", w/clip - 500 pcs - part # 2421633099

2300 Series for 5", 6"

Aluminum .047 with or without clip

Copper .050 with or without clip

Galvalume Plus Steel .040 with or without clip

A wider hanger, comes with 3 pre-drilled holes (so breaking a screw is no big deal!)

100 pcs/box - Aluminum (099), Solid Copper (890), Galvalume Plus Steel (920)

5", no clip - part # 2423501XXX

5", w/clip - part # 2423531XXX

6", no clip - part # 2423601XXX

6", w/clip - part # 2423631XXX

Mini-barrels - Aluminum

5", no clip - 500 pcs - part # 2423503099

5", w/clip - 500 pcs - part # 2423533099

6", no clip - 250 pcs - part # 2423602099

6", w/clip - 250 pcs - part # 2423632099

2800 Series for 5", 6"

Aluminum .047 with or without clip, #10 x 1.5" screw with T17 point, hi-low thread, 1000 hour black ruspert

Copper .050 with or without clip, #10 x 1.5" screw with T17 point, hi-low thread, stainless steel

Galvalume Plus Steel .040 with or without clip, #10 x 1.5" screw with T17 point, hi-low thread, 1000 hour black ruspert

Comes with Rattler™ front lip, and preloaded with 1.5" screw and washer for convenience.

100 pcs/box - Aluminum (099), Solid Copper (890)

5", no clip - part # 2428501XXX

5", w/clip - part # 2428531XXX

6", no clip - part # 2428601XXX

6", w/clip - part # 2428631XXX

Mini-barrels - Aluminum

5", no clip, 500 pcs - part # 2428503099

5", w/clip, 500 pcs - part # 2428533099

6", no clip, 250 pcs - part # 2428602099

6", w/clip, 250 pcs - part # 2428632099

100 pcs/box - Galvalume Plus Steel

5", no clip - part # 2428501920

5", w/clip - part # 2428531920

6", no clip - part # 2428601920

6", w/clip - part # 2428631920



K-STYLE INTERNAL HANGERS

2900 Series for 5", 6"

Aluminum .047 with or without clip, #10 x 2" screw with T17 point, hi-low thread, 1000 hour black ruspert
Galvalume Plus Steel .040 with or without clip, #10 x 2" screw with T17 point, hi-low thread, 1000 hour black ruspert

Comes with Rattler® front lip, and preloaded with 2" screw for convenience.

100 pcs/box - Aluminum (099),
 Galvalume Plus Steel (920)
 5", no clip - part # 2429501XXX
 5", w/clip - part # 2429531XXX
 6", no clip - part # 2429601XXX
 6", w/clip - part # 2429631XXX

Mini-barrels - Aluminum
 5", no clip, 500 pcs - part # 2429503099
 5", w/clip, 500 pcs - part # 2429533099
 6", no clip, 250 pcs - part # 2429602099
 6", w/clip, 250 pcs - part # 2429632099



3400 Series for 5", 6"

Aluminum .047 with or without clip, #10 x 3" screw with T17 point, hi-low thread, 1000 hour black ruspert

Strong & Convenient, comes preloaded with 3" screw.

100 pcs/box - Aluminum
 5", no clip - part # 2434551099
 5", w/clip - part # 2434571099
 6", no clip - part # 2434651099
 6", w/clip - part # 2434671099

Mini-barrels - Aluminum
 5", no clip, 500 pcs - part # 2434553099
 5", w/clip, 500 pcs - part # 2434573099
 6", no clip, 250 pcs - part # 2434652099
 6", w/clip, 250 pcs - part # 2434672099



3600 Series for 5", 6"

Aluminum .047 with or without clip, #12 x 3" screw with T17 point, hi-low thread, 1000 hour black ruspert

Strong & Convenient, comes preloaded with #12 screw.

100 pcs/box - Aluminum
 5", no clip - part # 2436551099
 5", w/clip - part # 2436571099
 6", no clip - part # 2436651099
 6", w/clip - part # 2436671099

Mini-barrels - Aluminum
 5", no clip, 500 pcs - part # 2436553099
 5", w/clip, 500 pcs - part # 2436573099
 6", no clip, 250 pcs - part # 2436652099
 6", w/clip, 250 pcs - part # 2436672099



3800 Series for 5", 6"

Aluminum .047, wider, with or without clip, #12 x 3" screw with T17 point, hi-low thread, 1000 hour black ruspert
Copper .050, with or without clip, #12 x 3" screw with T17 point, hi-low thread, 1000 hour black ruspert
Galvalume Plus Steel .040, with or without clip, #12 x 3" screw with T17 point, hi-low thread, 1000 hour black ruspert

A more robust version of the 3600 hanger, comes preloaded with #12 screw.

100 pcs/box - Aluminum (090), Solid Copper (890), Galvanized Steel (910)
 5", no clip - part # 2438551099
 5", w/clip - part # 2438571XXX
 6", no clip - part # 2438651099
 6", w/clip - part # 2438671XXX



3800 Series for 7"

Copper .050, with clip, #12 x 3" screw with T17 point, hi-low thread, stainless steel
Galvalume Plus Steel .040, with clip, #12 x 3" screw with T17 point, hi-low thread, 1000 hour black ruspert

A more robust 7" version of the 3600 hanger, comes preloaded with #12 screw.

100 pcs/box - Solid Copper, Galvalume Plus Steel
 7", w/clip - part # 2438771XXX



K-STYLE INTERNAL HANGERS

4000 Series for 5", 6"

Aluminum .055, with or without clip, #12 x 3.5" screw with T17 point, hi-low thread, 1000 hour black ruspert
Copper .050, with or without clip, #12 x 3.5" screw with T17 point, hi-low thread, stainless steel

Our strongest hanger, comes preloaded with #12 screw.

- 100 pcs/box - Aluminum (099), Solid Copper (890)
- 5", no clip- part # 2440551XXX
- 5", w/clip - part # 2440571XXX
- 6", no clip- part # 2440651XXX
- 6", w/clip - part # 2440671XXX

- Mini-barrels - Aluminum
- 5", no clip, 500 pcs - part # 2440553099
- 5", w/clip, 500 pcs - part # 2440573099
- 6", no clip, 250 pcs - part # 2440652099
- 6", w/clip, 250 pcs - part # 2440672099



4200 Series for 7"

Aluminum .060, with or without clip, #12 x 3" screw with T17 point, twin lead thread, 1000 hour black ruspert

7", .060 thick version of the 3800 hanger- Strong & Convenient, comes preloaded with #12 screw.

- 100 pcs/box - Aluminum
- 7", no clip - part # 2442761099
- 7", w/clip - part # 2442771099



7000 Series for 7"

Aluminum .060, without clip
Stainless Steel .060, without clip
Galvanized Steel .060, without clip

- 400 pcs/box
- 7", no clip- Aluminum- part # 2442731099
- 7", no clip- Stainless Steel- part # 2442731961
- 7", no clip- Galvanized Steel- part # 2442731910



T-Strap

100 pcs/box - Aluminum (099), Solid Copper (890), Stainless Steel (961)

10" T-Strap - part # 2499001XXX



9700 Series for 5", 6"

- 100 pcs/box - Aluminum
- 5", Vampire, w/strap - part # 2441511099
- 5", Vampire (rod sold separate) - part # 2441561099
- 6", Vampire, w/strap - part # 2441611099
- 6", Vampire (rod sold separate) - part # 2441661099
- 11" Vampire Rod - part # 2441001099



HALF ROUND

REVERSE BEAD HALF ROUND INTERNAL HANGERS

5000 Series for 6"HR

Aluminum .060 with or without clip

100 pcs/box - Aluminum
6", w/clip - part # 2450631099
6", no clip - part # 2450611099



Designed specifically for Half Round internal hangers, includes an extended wedge clip that sits against the fascia, preventing the gutter from tipping forward.

5100 Series w/ Wedge for 6"

Aluminum .060, with clip
Copper .050, with clip
Galvalume Plus Steel .040, with clip



100 pcs/box
part # 2451631XXX

5300 Series w/ Wedge for 6"

Aluminum .060, with clip, #12 x 3" screw with T17 point, hi-low thread, 1000 hour black ruspert
Copper .050, with #12 x 3" screw with T17 point, hi-low thread, stainless steel
Galvalume Plus Steel .040, with clip, #12 x 3" screw with T17 point, hi-low thread, 1000 hour black ruspert

100 pcs/box
part # 2453661XXX



Available in: Aluminum (099), Solid Copper (890), Galvalume Plus Steel (920)

Available in: Aluminum (099), Solid Copper (890), Galvalume Plus Steel (920)

HALF ROUND EXTERNAL HANGERS

6" #10 Combo w/Spring

50 pcs/box
part # 255004XXX



Available in: White (001), Brown (002), Dark Bronze (025), Solid Copper (890), Galvanized Steel (910)

6" Circle w/Spring, Nut, & Bolt

50 pcs/box
part # 255224XXX



Extra Spring

50 pcs/box
part # 255226XXX



Available in: White (001), Brown (002), Dark Bronze (025), Brass (870), Galvanized Steel (910)

#6 Shank for OG Crown Molding

50 pcs/box
part # 255106XXX



Available in: Solid Copper (890), Galv Steel (910)

#25 Shank Sheeting 1/2 Pitch

50 pcs/box
part # 255115XXX



Available in: Solid Copper (890), Galv Steel (910)

#11 Shank Exposed Rafter 1/3 Pitch

50 pcs/box
part # 255111XXX



Available in: White (001), Brown (002), Solid Copper (890), Galvanized Steel (910)

#12 Shank Sheeting 1/3 Pitch

50 pcs/box
part # 255112XXX



Available in: White (001), Brown (002), Dark Bronze (025), Solid Copper (890), Galvanized Steel (910)

#30 Shank Adjustable Pitch w/Nut & Bolt

50 pcs/box
part # 255116XXX



Available in: White (001), Brown (002), Dark Bronze (025), Solid Copper (890), Galvanized Steel (910)

5800 Series

25 pcs/box
part # 2558721XXX



Available in: 26 Traditional, 1 Duel Tone®(129), 3 Armor Tough®, 16 oz. Solid Copper (890), Galvalume Plus Steel (920)

Extra Bolt w/Nut #10/24 x 3/4"

50 pcs/box
part # 255228XXX

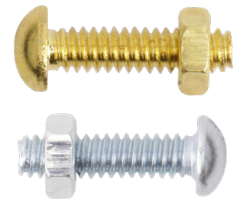

Available in: Brass (870) Galvanized Steel (910)

END CAPS FOR HALF ROUND

Packaged 25 Pcs/Box

6" Right or Left

right - part # 2266030XXX

left - part # 2266050XXX



Right



Left

Available in: 26 Traditional, 1 Duel Tone® (129), 3 Armor Tough®, 16 oz. Solid Copper (890), Galvalume Plus Steel (920)

MITERS FOR HALF ROUND

Packaged 20 Pcs/Box

6", 90°, Strip, O/S or I/S

O/S - part # 2366110XXX

I/S - part # 2366130XXX



6", 45°, Bay, O/S or I/S

O/S - part # 2366310XXX

I/S - part # 2366330XXX



Available in: 26 Traditional, 1 Duel Tone® (129), 3 Armor Tough®, 16 oz. Solid Copper (890), Galvalume Plus Steel (920)

OUTLETS FOR HALF ROUND

Packaged 50 Pcs/Box

3" Round

part # 2653640XXX



Available in: White (001), Solid Copper (890),
Galvanized Steel (910)

4" Half Round

part # 2654440XXX



Available in: Black (004), Solid Copper (890),
Galvanized Steel (910)

BLACK MAX® MINI PUNCH PAK FOR HALF ROUND

Everything you need to install half round outlets; the Mini Punch Pak includes Punch, 1 1/2" Hole Saw, 1/4" Driver Power Bit, and bulk savings on the outlets you need.

4" Half Round

10 Outlets

part # 2654448004

Includes: Punch, 1 1/2" Hole Saw, 1/4" Driver Power Bit, Outlets



GUTTER WEDGES FOR REVERSE BEAD HALF ROUND

Gutter Bumper® HR

100 pcs/box

part # 2928660XXX

Available in: 30° White (001), Black (004),
16 oz. Solid Copper (890),
Galvalume Plus Steel (920)

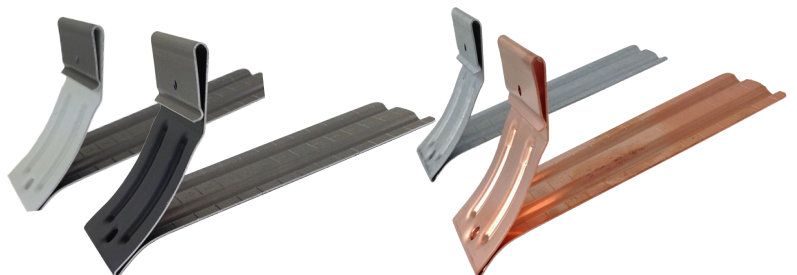

GUTTER GUARDS

ALUMINUM EXPANDED WIRE GUTTER GUARD

Our most cost effective solution for keeping your customer's gutters debris-free.

Drop-In

4' pcs, 50 pcs/box
5" - part # 3813050099
6" - part # 3813060099

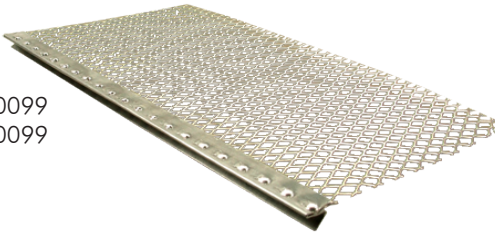

Fast Screen

4' pcs, 50 pcs/box
5" - part # 3815050099
6" - part # 3815060099

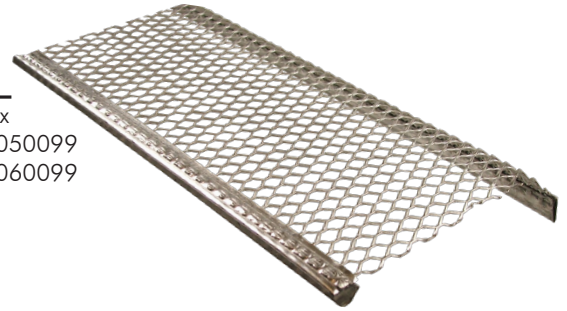

Available in: Aluminum

POWDER COATED EXPANDED WIRE GUTTER GUARD

Powder coated galvanized steel provides superior rust, rodent, and debris protection for decades to come.

Roll Lock

4' pcs, 25 pcs/box
5" - part # 3821050XXX
6" - part # 3821060XXX
7" - part # 3821070XXX

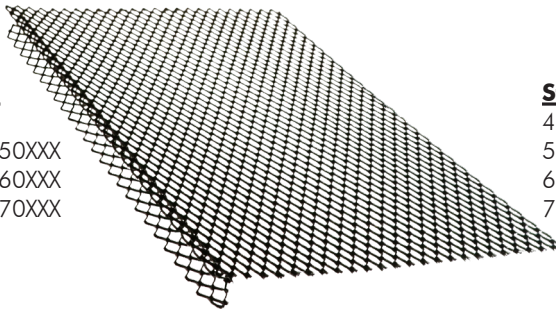

Step Lock

4' pcs, 25 pcs/box
5" - part # 3823050XXX
6" - part # 3823060XXX
7" - part # 3823070XXX

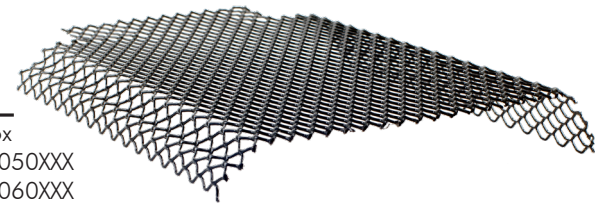

Flat Lock

4' pcs, 25 pcs/box
6" - part # 3825060XXX
7" - part # 3825070XXX
8" - part # 3825080XXX
9" - part # 3825090XXX

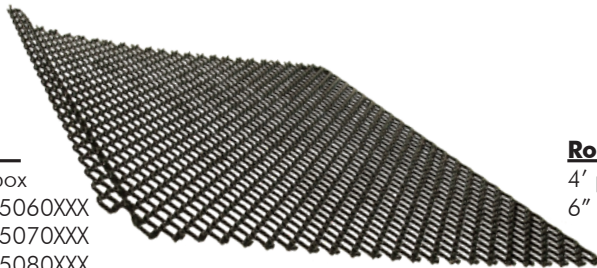

Round Lock for HR 6"

4' pcs, 25 pcs/box
6" - part # 3827060XXX

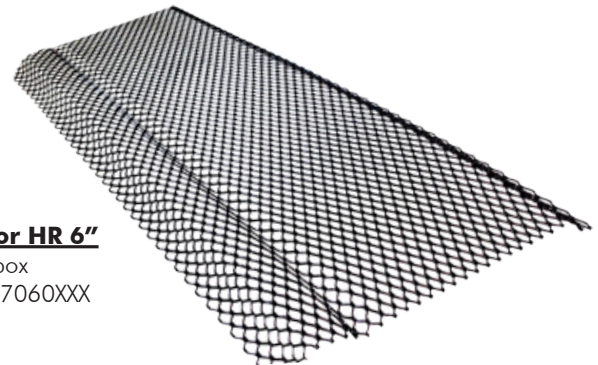

Available in: Black (004), Solid Copper (890)

PERFORATED GUTTER GUARD

Senox perforated gutter guards keep more debris from entering gutters and make cleaning them a breeze.

Eave N Flow

4' pcs, 50 pcs/box
5" - part # 3914050004
6" - part # 3914060004

Available in: Black

Eave N Flow Elite

4' pcs, 50 pcs/box
5" - part # 3915050XXX
6" - part # 3915060XXX

Available in: White (001), Black (004)

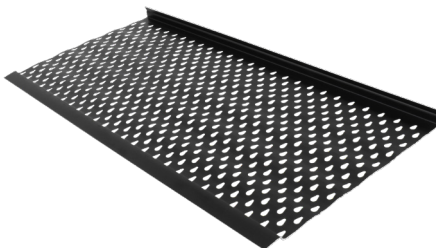

Smart Flow

4' pcs, 50 pcs/box
5" x 4' - part # 3914000XXX
6" x 4' - part # 3914010XXX
10' pcs, 25 pcs/box
5" x 10' - part # 3914100XXX
6" x 10' - part # 3914110XXX
7" x 10' - part # 3914120XXX

Available in: White (001), Black (004)

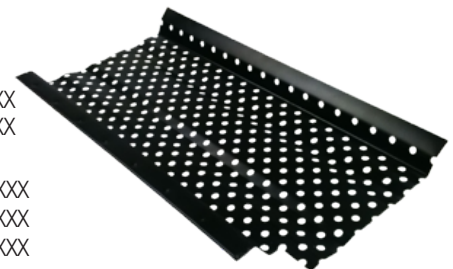

STAINLESS STEEL METAL MESH GUTTER GUARD

For areas with fine debris like pine needles, metal mesh gutter guards provide the ultimate in debris protection.

Mesh Guard

4' pcs, 25 pcs/box
5" - part # 3930050004
6" - part # 3930060004

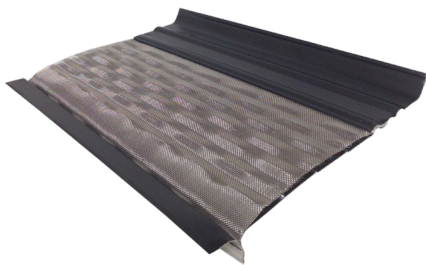

Available in: Black

Mesh Guard Panel

4' pcs, 25 pcs/box
part # 3931050XXX

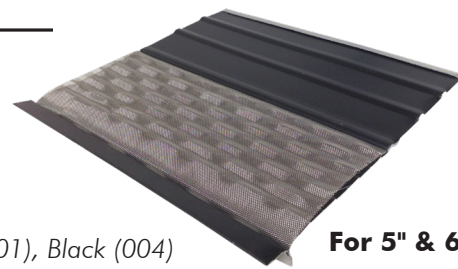

Available in: White (001), Black (004)

For 5" & 6"

LOUVERED GUTTER GUARD

Leaf protection that is as easy to install as it is to clean.

E-Z Leaf Sweep

4' pcs, 25 pcs/box
5" - part # 3924050XXX
6" - part # 3924060XXX



Available in: White (001), Black (004)

E-Z Leaf Protection

4' pcs, 25 pcs/box
part # 3925050XXX



Available in: White (001), Black (004)

For 5" & 6"

SOLID GUTTER GUARD

Solid gutters guards use surface tension to direct water over the front and into the gutter. Unique patent pending gap system protects the gutter without clogging the outlets.

LeafFree

4' pcs, 25 pcs/box
part # 395215XXX



For 5" & 6"

Leaffree High Water Flow

4' pcs, 25 pcs/box
part # 395225XXX



For 5" & 6"

Available in: 30° White (001), Royal Brown (002), Antique Ivory (003), Black (004), Clay (008), Sherwood Green (010), Musket Brown (011), Wicker (013), Almond (015), Linen (017), Light Bronze (018), Tuxedo Gray (019), Heritage Cream (020), Colonial Gray (021), Colonial Red (024), Dark Bronze (025)

*Solid Copper Special Order

LeafFree Endcap

25 pcs/box
Right- part # 395255XXX
Left- part # 395265XXX



LeafFree Inside Miter (2 pc)

10 sets/box
part # 395285XXX

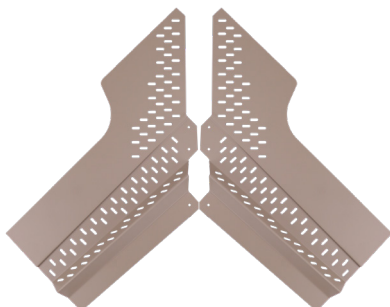

Midwest Solid

4' pcs, 25 pcs/box
5" - part # 395015XXX
6" - part # 395016XXX

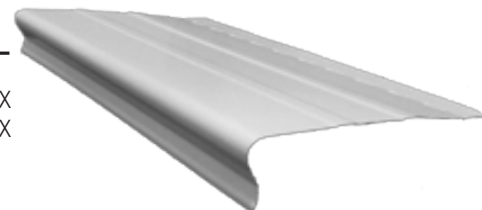

Available in: 30° White (001), Royal Brown (002), Black (004), Clay (008), Wicker (013), Almond (015), Light Bronze (018), Colonial Gray (021)

SPLASH BLOCKS

Plastic, Slate, 10" x 21"

10 pcs/box
Gray - part # 612100014
Tan - part # 612100017



Concrete, 11" x 18"

100 pcs/pallet
Gray - part # 611115014



Concrete, 12" x 12"

160 pcs/pallet
Gray - part # 611110014



FLEX-DRAIN® UNDERGROUND DRAINAGE & ADAPTORS

Packaged 1 Unit/Box

FLEX-Drain® 4" x 12' Perforated Pipe

part # 622512004



FLEX-Drain® 4" x 25' Solid Pipe

part # 622516004



FLEX-Drain® 4" Coupler

part # 622520004



FLEX-Drain® 4" Flexible T/Y

part # 622525004



FLEX-Drain® 2" x 3" x 4" Downspout Adapter

part # 622522004



FLEX-Drain® 3" x 4" x 4" Downspout Adapter

part # 622524004



Available in: Black

UNIVERSAL DRAINAGE & ADAPTORS

Packaged 1 Unit/Box

2" x 3" DS to 4" Universal

part # 623022004



3" x 4" DS to 4" Universal

part # 623024004



Available in: Black

RIVETS #42 X 1/8"

Packaged 100 Pcs/Bag

A wide selection of colors are available to more effectively blend with Senox gutters.

Aluminum, Painted

part # 521421XXX

Available in: All Senox colors

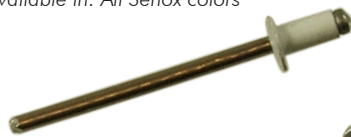

Steel, Zinc Plated

part # 521421905



Solid Copper Barrel, Copper Plated Mandrel

part # 521421890

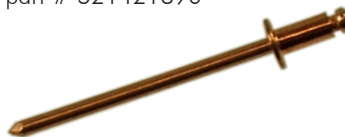

RIVETS #44 X 1/8"

Packaged 100 Pcs/Bag

Rivet #44 x .125"

part # 521441001

Available in: 30 White



#8 SCREWS

1/4" Hex Head, 1/2" 1000 Hour Black Ruspert Coating

100 ct. - part # 511211XXX

1000 ct. - part # 511212XXX



Available in: All Senox colors

1/4" Hex Head

1/2" Zinc Plated

100 ct. - part # 511211905

1000 ct. - part # 511212905



1/4" Hex Head

1/2" Copper Plated Stainless Steel

100 ct. - part # 511211967



SENOX SPEED MASTER® SCREWS

Senox Speed Master® screws are the only ones on the market specifically designed for gutter installation, coated with a long lasting black ruspert finish to better prevent corrosion.

Packaged 250 Pcs/Bag

#10 x 1 1/2" No Washer, 1000 Hour Black Ruspert Coating

part # 513042904

#10 x 1 1/2" With Washer, 1000 Hour Black Ruspert Coating

part # 513142904

#10 x 2" No Washer, 1000 Hour Black Ruspert Coating

part # 513052904

#10 x 2" With Washer, 1000 Hour Black Ruspert Coating

part # 513152904



Packaged 50 Pcs/Bag

#10 x 1 1/2" With Washer Stainless Steel

part # 95513144961



#10 x 2" With Washer Stainless Steel

part # 95513154961



NAILS, DRIVE PINS, & ANCHORS

1" Masonry Galvanized Steel

5 lb. - part # 531412910



1 1/2" Masonry Galvanized Steel

5 lb. - part # 531432910



#10 1/4" Plastic Anchor

100 ct. - part # 541210099



PAINT/SEALANT

TOUCH-UP PAINT

Packaged 12 Pcs/Box

Brush-On Paint, 0.6 oz.

part # 581006XXX



Available in: 26 Traditional,
1 Duel Tone®, 3 Armor Tough®

Spray-On Paint, 12 oz.

part # 582160XXX

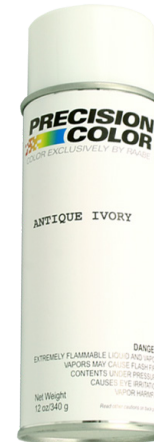

Available in: 26 Traditional, 3 Armor Tough®

SEALANT - NITRILE RUBBER BASE

Packaged 24 Pcs/Box

Rusco PSCG, 1/10 Gallon

part # 591141014



Rusco PSCG-HV, 1/10 Gallon

part # 591142014



SEALANT - TRIPOLYMER BASE

Packaged 24 Pcs/Box

Geocel 2320, 1/10 Gallon

part # 593320XXX



Available in: White, Gray, Clear

SEALANT - SBR RUBBER BASE

Packaged 24 Pcs/Box

OSI GS121, 1/10 Gallon

part # 592121001



Available in: White

SEALANT - HYBRID POLYMER BASE

Seal Bond SB-415, 10.1 oz.

part # 593350014



AVIATION SNIPS

Max 2000, Left

part # 891M2001



Max 2000, Right

part # 891M2002



Max 2000, Straight

part # 891M2003



OFFSET SNIPS

Max 2000, Left

part # 891M2006



Max 2000, Right

part # 891M2007



STRAIGHT SNIPS

Straight Snips, 12"

part # 891M12N

part # 891M12A



Straight Snips, 14"

part # 891M14N

part # 891M14A



COMBINATION SNIPS

Combination Snips, 12"

part # 891MC12N

part # 891MC12A



Combination Snips, 14"

part # 891MC14N

part # 891MC14A



END CAP CRIMPERS

Snap Lock Punch

part # 894SL1R



DOWNSPOUT CRIMPERS

Single Blade
part # 894SC1

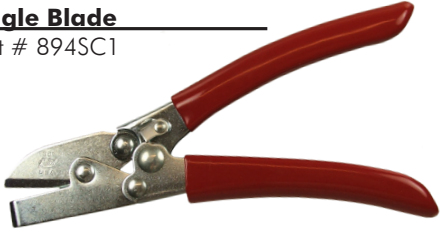

3-Blade
part # 894SC3R



5-Blade
part # 894C4R



MAX2000 Double-Cut
part # 891M2004



HAND SEAMERS

3"
part # 894S2R



Offset, 3"
part # 894S3R



6"
part # 894S6R



Tool Replacement Spring
part # 8945018



CAULKING, DRIVERS, & LEVELING

Nut Driver, 1/4"
1 3/4" - part # 895MSH14
2 9/16" - part # 895MSHL14
4" - part # 895MSHML14
6" - part # 895MSHXL14
8" - part # 895MSHL148
Impact 6" - part # 895MSHXL14I



Torpedo Level, 9"
part # 898L9



Hand Riveter, Economy
part # 896CR18



Vampire T-Bar Tool
part # 89717232



Caulking Gun
part # 898CG12



CUTTING & DRILLING

Hole Saw 1 1/2"

part # 8926928



Hole Saw 2 3/8" & 2 3/4"

2 3/8" part # 892H38

2 3/4" part # 892H44



Quick Open Utility Knife

part # 8929PK



Hole Saw Pilot Bit

part # 892HSB



#30 Double Ended Bit 1/8"

part # 896NDE30



Grease Crayon, White, .43 oz.

part # 899WLB2



ProTouch Combi-Saw

part # 892218HP300



12" 32 TPI Hacksaw Blade

part # 89220146V232HE



Saw Blade Lubricant Stick

part # 899LUBS



LADDER ACCESSORIES

Ladder Max

part # 898162100



Ladder Guards

part # 898165510



Ladder Max Multi-Pro

part # 898162110

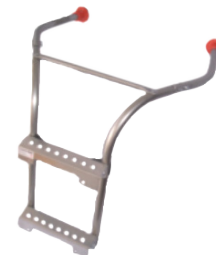

MISCELLANEOUS ACCESSORIES

Wasp Spray, 20 oz.

part # 899WASP



Trough Mate

part # 898TM614



Extension Cord, 50', 10 ga.

part # 898ECORD50



JOINTS

Expansion Joints for K-Style 5", 6"

1 unit/box

5" - part # 293305099

6" - part # 293306099

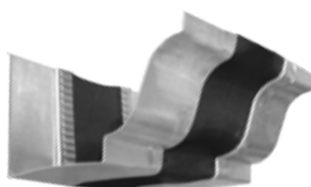

Available in: Aluminum

RAIN CHAINS

Lotus Cup

Painted Aluminum

part # 494061XXX

Available in: Black (004),
Pewter/Dark Bronze (025)



BLACK

Lotus Cup

Copper

part # 494061890

Available in: Solid Copper



COPPER

Hammered Cup

Painted Aluminum

part # 494021XXX

Available in: Black (004), Dark Bronze (025)

Hammered Cup

Copper

part # 494021890

Available in: Solid Copper



BLACK



DARK BRONZE/PEWTER



SOLID COPPER

Gutter Reducer Adaptor

Copper

part # 494111890



Rain Chain Anchoring Stakes

part #494081890 Copper Chain, Brown Stake

part #494081961 Stainless Steel Chain, Black Stake

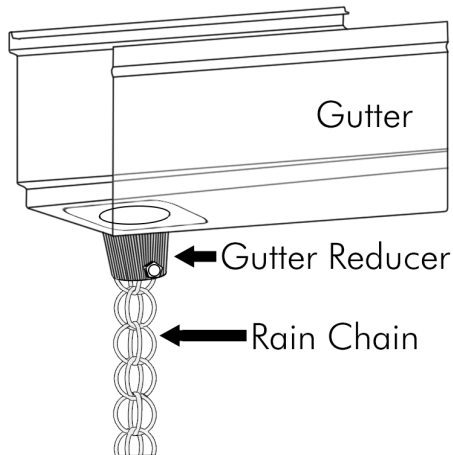

Gutter Reducer Adaptor

Black

part # 494111004



CONDUCTOR HEADS

Packaged 1 Unit/Box

Senox conductor heads are available in a wide variety of sizes and colors, to perfectly finish the job with no modifications needed.

Plain

2" x 3" & 3" x 4" Rectangle Outlet

2" x 3" - part # 441005XXX

3" x 4" - part # 441006XXX

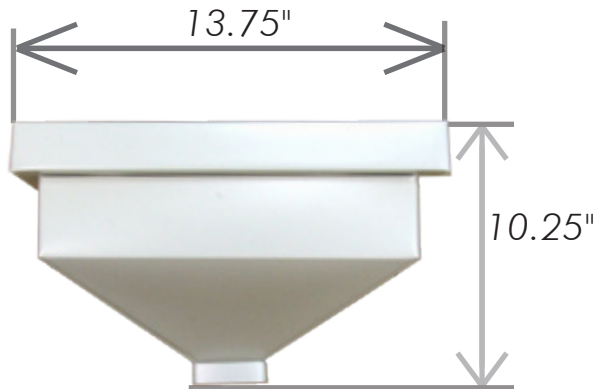

Available in: 30° White (001), 16 oz. Solid Copper (890), Galvalume Plus Steel (920)

Decorative

3" & 4" Oval Outlet

3" - part # 441201XXX

4" - part # 441203XXX

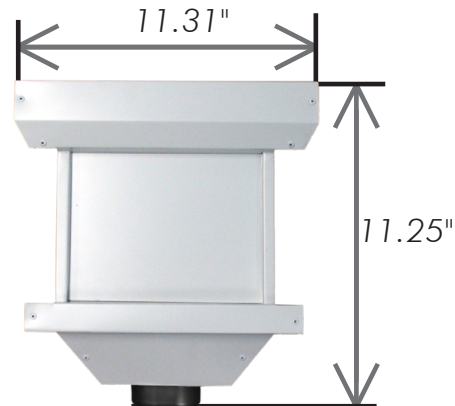

Available in: 26 Traditional, 1 Duel Tone® (129), 3 Armor Tough®, 16 oz. Solid Copper (890), Galvalume Plus Steel (920)

Ornamental

3" & 4" Round Outlet

3" - part # 442008XXX

4" - part # 442009XXX

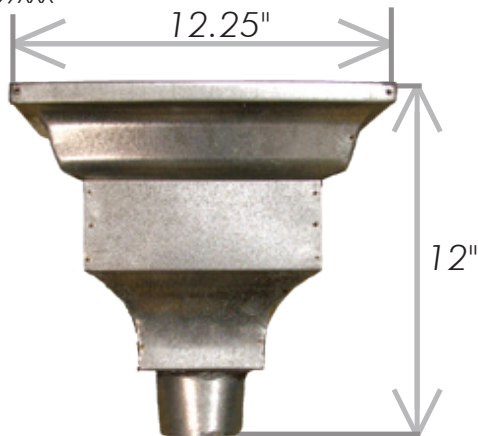

Available in: 16 oz. Solid Copper (890), Galvanized Steel (920)

Basic

4" Round Outlet

part # 441603001

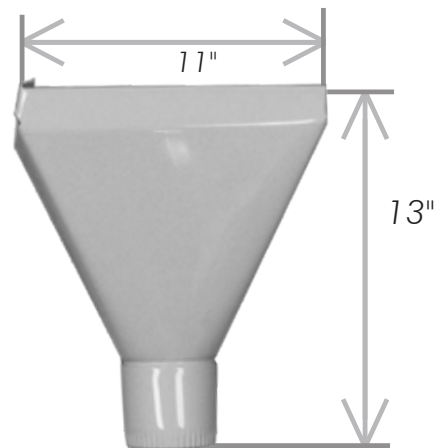

Available in: 30° White

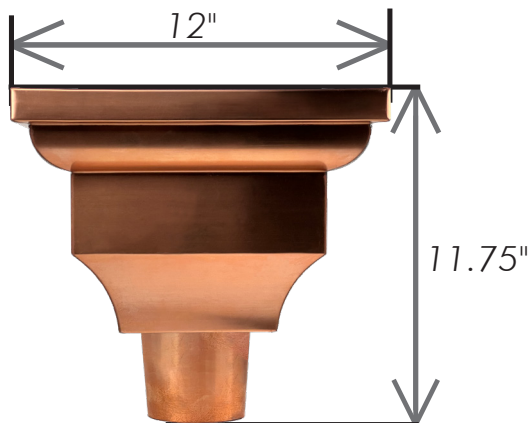

the Complete Boxer™ Style Gutter System

Now Available!
 Exclusively from

SENOX®



The new 6" Boxer™ machine is now in stock, and provides a number of features such as the exclusive z"Pocket Lock" lip, 90° strengthening cutout, & Leaf Rib Roller. Pair with Senox Boxer™ End Caps to produce the ultimate box-style gutter!



6" Boxer
 (base machine w/ dongle & rib roller)
 part # 8180160251



6" Boxer
 Height: 17"
 Width: 24"
 Length: 139.75"
 Weight: 1200 lbs (base machine)

The new Leaf Rib feature allows you to add a strengthening rib to the bottom of the gutter, making oilcanning a thing of the past. Adding the rib is like increasing the material thickness without requiring any additional material, creating a stronger profile for the same cost!

Boxer Front Pull Guillotine

6" Boxer
 part # 8180300261



Boxer End Plate (No Shear)

6" Boxer
 part # 8180350261

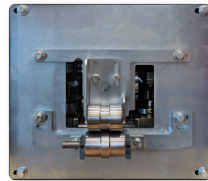

BOXER ENDCAPS

For 6" Boxer

25 pcs/box - Aluminum,
 (all colors), Copper (890),
 and Galvalume Plus Steel (920)

6" Right - part # 3246030XXX
 6" Left - part # 3246050XXX



***For Smooth Downspouts & Elbows, see page 8**

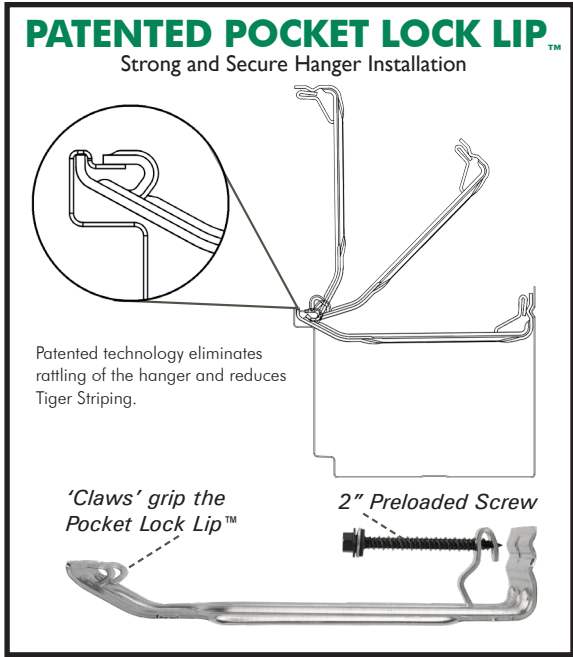

BEARCLAW HANGERS

For 6" Boxer

100 pcs/box - Aluminum (099), Copper (890), and Galvalume Plus (920)
6", no clip, with screw - part # 3455601XXX



BEARCLAW GUTTER GUARD

For 6" Boxer

25 pcs/box - Aluminum (099), Copper (890)
BearCLAW Expanded 6" x 4'-
part # 383106XXX

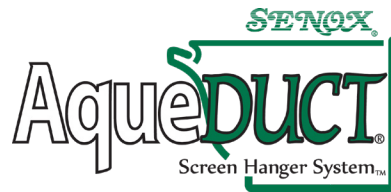

AQUEDUCT SCREEN HANGERS

For 6" Boxer

25 pcs/box
Screen Hanger, 6" x 4' - part # 3540060XXX

Available in:

Black Aluminum (004), Copper (890), and Galvalume Plus (920)

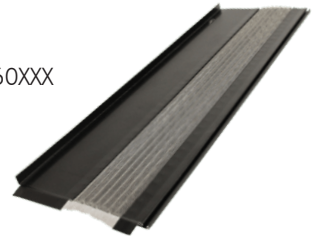

AQUEDUCT MITERS

For 6" Boxer

20 pcs/box
Strip, 6", 90°, O/S & I/S
part # 334311961

Bay, 6", 45° O/S & I/S
part # 334331961

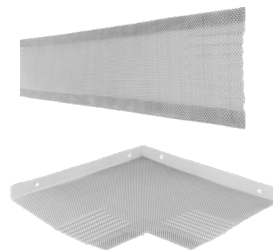

AQUEDUCT INSTALLATION TOOL

Installation Tool, 6"
part #8L354006



6.5 HALF ROUND WEDGER

Height: 19"
 Width: 24"
 Length: 161"
 Weight: 1574 lbs (base machine)



6.5" Half Round Wedger Gen 2
 part # 8180202661

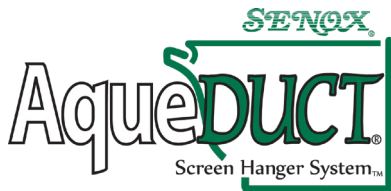
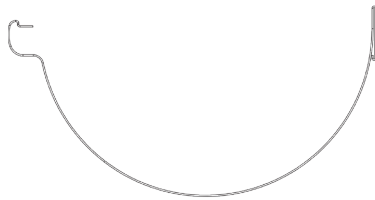

AQUEDUCT SCREEN HANGERS

For 6.5" HR

25 pcs/box
 Screen Hanger, 6.5" x 4' - part # 3540650XXX
 Available in:
 Black Aluminum (004), Copper (890),
 and Galvalume Plus Steel (920)

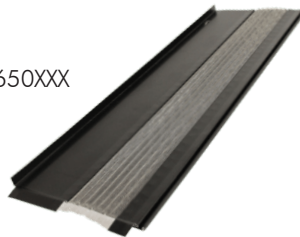

BEARCLAW HANGERS

For 6.5" HR

100 pcs/box - Aluminum
 6", no clip, with screw - part # 3455601099
 6.5" HR, with screw - part # 3455651099



BEARCLAW GUTTER GUARD

For 6.5" HR

25 pcs/box
 BearCLAW Expanded 6" x 4'-
 part # 383106XXX
 BearCLAW Expanded 6.5" x 4' HR-
 part # 383166XXX

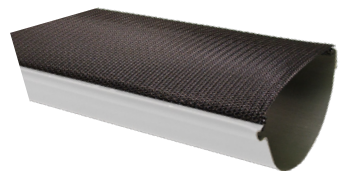

AQUEDUCT MITERS

For 6.5" HR

20 pcs/box
 Strip, 6.5", 90°, O/S & I/S
 part # 334511961

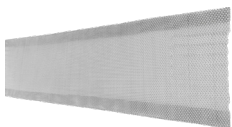

Bay, 6.5", 45° O/S & I/S
 part # 334531961

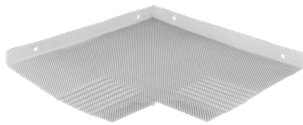

**AQUEDUCT
 INSTALLATION TOOL**

Installation Tool, 6.5"
 part #8L354065



SENOX BARRACUDA® GUTTER MACHINES

A quality gutter machine is the cornerstone of all successful gutter businesses, and it is incredibly important to make sure you have a reliable machine that will do exactly what you need to satisfy your customers. Contact your Senox representative before purchasing to help match you with the perfect machine for you.



5" K-Style
2' x 4' x 6' 9"
part # 81112001501

5"/6" Combo K-Style
2' x 4' x 9"
part # 81112001511

6" K-Style
2' x 4' x 9"
part # 81112001601

6"/7" Combo K-Style
2' x 4' x 12' 7"
part # 81112001621

7" K-Style
2' x 4' x 12' 7"
part # 81112001701

6" Reverse Bead Half Round
2' x 4' x 14"
part # 81112016601



SENOX BARRACUDA® GUTTER MACHINE OPTIONS

Everything you need to get the most out of your Barracuda® gutter machine.

Front Pull Guillotine

5" & 5"/6" Combo
part # 8111300151

7" & 6"/7" Combo
part # 8111300172

6" & 5"/6" Combo
part # 8111300161

6" & 6"/7" Combo
part # 8111300162

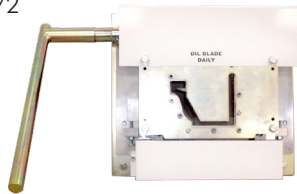

End Plate (No Shear)

5" & 6" & 5"/6" Combo
part # 8111350151

7" & 6"/7" Combo
part # 8111350172



Full Coil Cradle Machine Mount

5" & 6" | 5"/6" Combo | 6"HR
part # 811140151

7" | 6"/7" Combo
part # 811140172

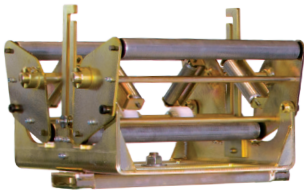

Spin Coil Cradle Machine Mount

w/Single Scuff Bar & Side Roller Assembly
part # 811145151

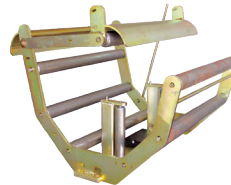

Side Roller Assembly For Cradle

part # 81904505



Spool w/ Shaft

5" & 6" & 5"/6" Combo, 6" HR
part # 811160151

7" & 6"/7" Combo
part # 811160172

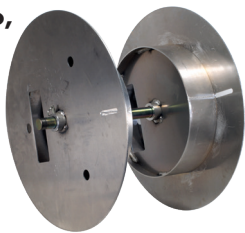

Upright Turnstile

5" & 6" | 5"/6" Combo | 6"HR
part # 811150151

7" & 6"/7" Combo
part # 811150172



Transfer Bar Set

Fits All Sizes
part # 811165001

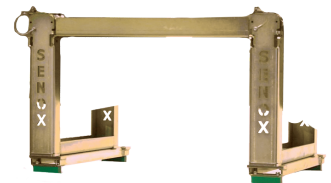

Standard Run Out Stand w/ Adjustable Leg

5" & 6" & 5"/6" Combo, 6" HR
part # 811180100

7" & 6"/7" Combo
part # 811180107



Deluxe 3 Roller Run Out Stand w/ Adjustable Leg

5" & 6" & 5"/6" Combo, 6" HR
part # 811180130



Machine Stand Riser Pad, Tall

Fits All Machines
part # 811190001

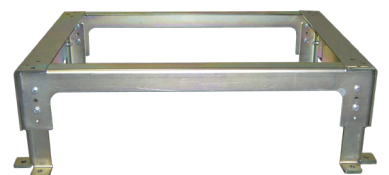

1. The front lip and associated hangers are available in K-Style (K-STYLE), Pocket Lock Lip (PLL), and Reverse Bead Half Round (RBHR).

2. The face and bottom are available in Ogee (OG), Flat Face (FF), and Half Round (HR).

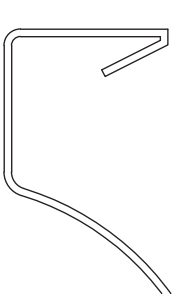

K-Style Lip
(K-STYLE)



Pocket Lock Lip
(PLL)

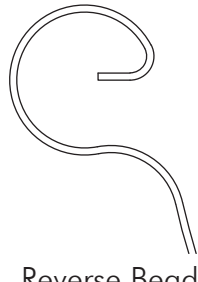

Reverse Bead
Half Round
(RBHR)

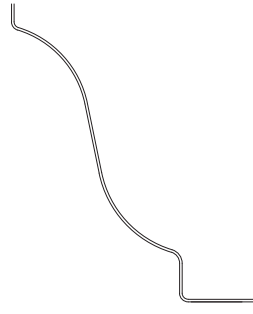

Ogee
(OG)

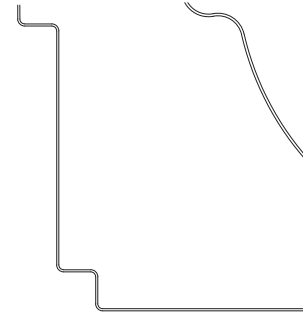

Flat Face
(FF)

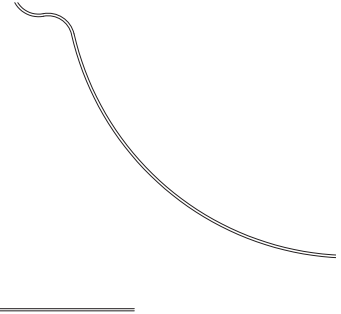

Half Round
(HR)

3. The back and gutter bumpers are available in Straight Back (SB), Straight Back High/Low (SBHL), Half Round Reverse Bead (HR), Half Round Wedger (HW), and Half Round High Back (HH).

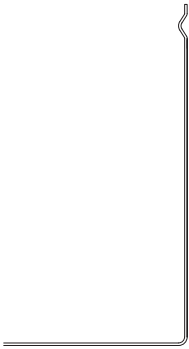

Straight Back
(SB)

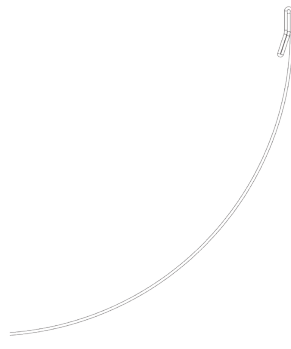

Half Round Reverse
Bead
(HR)



Half
Round
Wedger
(HW)

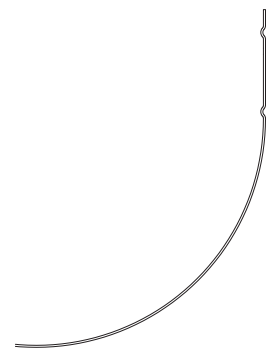

Half Round High
Back
(HH)

The major discrepancy in everyone's mind is centered around OG vs. K-Style. Our opinion is OG speaks to the shape of the gutter face. This shape has been around since the Greeks. K-Style describes the hanger style and front lip design on the top of the OG shape. Over time the K-Style front lip and the OG shape have become synonymous in people's minds. Because of the new styles of front lips and hangers, this thinking needs to be separated to allow us to describe them separately. Our additional designs for the back of the gutter also call for more precise definitions.

—A.B. Walters
Founder & President

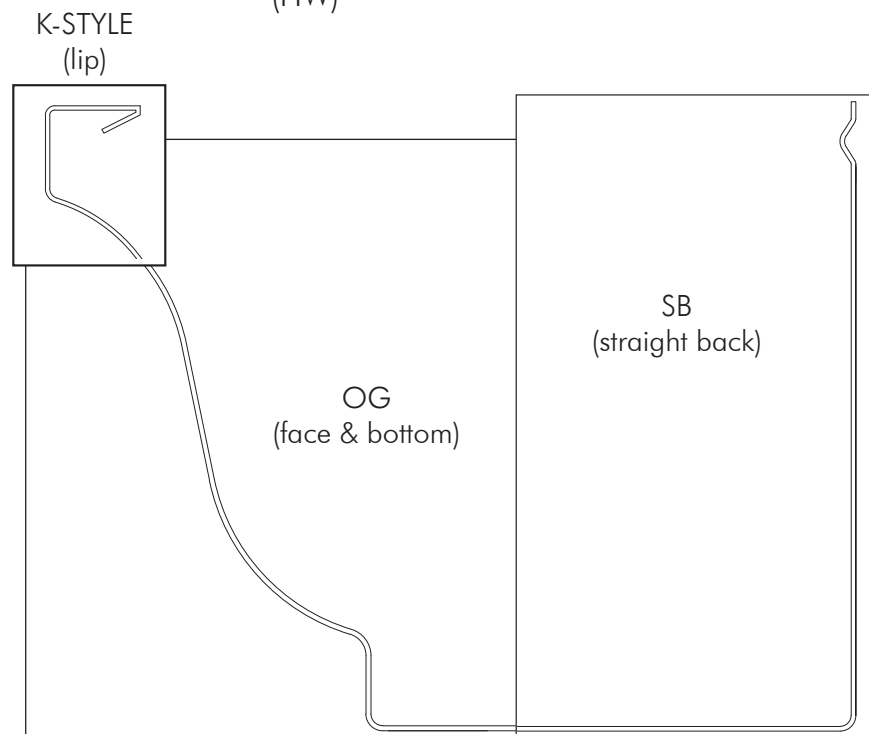

A

- Accessories, Downspout 10
- Accessories, Ladder 23
- Accessories, Miscellaneous 23
- Adaptors, Underground Drainage 18
- Anchors, Nails, & Drive Pins 19
- AqueDUCT (for Boxer)..... 27
- AqueDUCT (for HR)..... 28
- Aviation Snips 21

B

- Bar w/ Rod for 6" 13
- Barracuda Gutter Machines, Senox 29
- Barracuda Gutter Machine Options, Senox 29
- BearCLAW (for Boxer) 27
- BearCLAW (for HR) 28
- Black MAX Punch Pak Flat Bottom Gutter 5
- Black MAX Mini Punch Pak Flat Bottom Gutter 5
- Black MAX Punch Replacement Accessories 5
- Blade, Hacksaw 23
- Bolt w/ Nut 14
- Boxer Gutter Machine 26

C

- Caulking, Drivers, & Leveling 22
- Circular "Duckbill" Snips 21
- Coil, Seamless Gutter 4
- Combination Snips 21
- Combi-Saw 23
- Conductor Heads 25
- Copper Flat Sheets, Solid 6
- Crimpers, Downspout 22
- Crimpers, End Cap 21
- Cutting & Drilling 23

D

- Downspout Accessories 10
- Downspout Crimpers 22
- Downspout Hangers 10
- Downspouts, Rectangular 7
- Downspouts, Round 9
- Downspouts, Smooth..... 8
- Drainage & Adaptors 18
- Drilling & Cutting 23
- Drip Cap 6
- Drip Edge 6
- Drive Pins, Anchors, & Nails 19
- Drivers, Leveling, & Caulking 22
- Duckbill Snips, Circular 21

E

- Elbows, Rectangular 7
- Elbows, Round 9
- Elbows, Smooth..... 8
- End Cap Crimpers 21
- End Caps for Half Round 15
- End Caps for K-Style 4
- Expansion Joints for K-Style 23
- Extension Cord 23
- External Hangers, Half Round 14

F

- Flashing 6
- Flat Sheets, Solid Copper 6
- FLEX-Drain Underground Drainage & Adaptors 18

G

- Grease Crayon 23
- Gutter Bumper HR 15
- Gutter Bumper SB 6
- Gutter Coil, Seamless 4

- Gutter Guard, Aluminum Expanded Wire 16
- Gutter Guard, LeaFree..... 17
- Gutter Guard, Louvered 17
- Gutter Guard, Perforated 16
- Gutter Guard, Powder Coated Expanded Wire ... 16
- Gutter Guard, Solid 17
- Gutter Guard, Stainless Steel Metal Mesh 17
- Gutter Machine Options, Senox Barracuda 29
- Gutter Machine Options, Senox Boxer 26
- Gutter Machine Options, Half Round Wedger 28
- Gutter Machines, Senox Barracuda 29
- Gutter Machines, Senox Boxer 26
- Gutter Machines, Half Round Wedger 28
- Gutter Sections, Reverse Bead Half Round 15
- Gutter Wedges for Reverse Bead Half Round 15

H

- Hacksaw Blade 23
- Half Round External Hangers 14
- Half Round Gutter Sections, Reverse Bead 15
- Half Round Internal Hangers, Reverse Bead 14
- Half Round Miters 15
- Half Round Outlets 15
- Hand Riveters 22
- Hand Seamers 22
- Hangers, Downspout 10
- Hangers, K-Style Internal 11-13
- Hangers, Reverse Bead Half Round Internal 14
- Hangers, Half Round External 14
- Hole Saw 1 1/2", for Punch 5, 23
- Hole Saw 23

I

- Internal Hangers, BearCLAW (for Boxer) 27
- Internal Hangers, BearCLAW (for HR) 28
- Internal Hangers, Reverse Bead Half Round 14
- Internal Hangers, K-Style 11-13

J

- Joints 23

K

- K-Style Internal Hangers 11-13

L

- Ladder Accessories 23
- LeaFree Gutter Guard..... 17
- LeaFree Encaps 17
- LeaFree Inside Miters 17
- Leveling & Drivers 22
- Lubricant, Saw Blade 23

M

- Mini Punch Pak Flat Bottom Gutter, Black Max 5
- Mini Punch Pak Half Round, Black Max 15
- Miscellaneous Accessories 23
- Miters for Half Round 15
- Miters for K-Style 4

N

- Nails, Drive Pins, & Anchors 19

O

- Offsets, Custom 9
- Offsets, Rectangular 7
- Offsets, Round 9
- Offset Snips 21
- OSI Sealant 20
- Outlets for Flat Bottom Gutter 5
- Outlets for Half Round 15

P

- Paint, Touch-Up 20
- Pipe Bands, Downspout Hangers 10
- Punch Pak Flat Bottom Gutter, Black MAX 5
- Punch Pak Flat Bottom Gutter, Black MAX Mini ... 5
- Punch Pak Half Round, Black MAX Mini 15
- Punch Replacement Accessories, Black MAX 5

R

- Rain Chains 24
- Rectangular Downspouts 7
- Rectangular Elbows 7
- Rectangular Offsets 7
- Regular Pattern Snips 21
- Reverse Bead Half Round Gutter Sections 15
- Reverse Bead Half Round Internal Hangers 14
- Rivets, #42 x 1/8" 19
- Round Downspouts 9
- Round Elbows 9
- Round Offsets 9
- Ruscoe Sealants 20

S

- Saw Blade Lubricant 23
- Screws, #8 19
- Screws, SpeedMaster® 19
- Sealant, Nitrile Rubber Base 20
- Sealant, SBR Rubber Base 20
- Sealant, Tripolymer Base 20
- Seamers, Hand 22
- Seamless Gutter Coil 4
- Smooth Downspouts 8
- Smooth Elbows 8
- Snips 21
- Solid Copper Flat Sheets 6
- Splash Blocks 18
- Straight Snips 21
- Stamped Bracket, 5800 Series 14

T

- Touch-Up Paint 20
- T-Strap, 9000 Series 13
- Torpedo Level 22
- Trough Mate 23

U

- Underground Drainage & Adaptors 18

W

- Wedges for Reverse Bead Half Round, Gutter 15









JOB ESTIMATE FORM

CUSTOMER INFORMATION

Name _____
 Address _____
 City, State Zip _____
 Home Phone _____
 Work Phone _____

JOB INFORMATION

Gutter Color _____ INITIAL
 K-Style 5" 6" 7" Half Round 6"
 Downspout Color _____ INITIAL
 Round 3" 4" Rectangle 2"x3" 3"x4" 4"x5"
 Roof Type _____ Fascia Type _____
 Walkable Y N
 Stories 1 2 3+ Remove Existing Y N Haul Away Y N

 DOWN SPOUT	 GUTTER
 SPLASH GUARD	 EXISTING GUTTER
 SPLASH BLOCK	 DIVERTER
 DROP OUTLET	 ELEVATION CUT

GUTTER _____	
END CAPS _____	
RIGHT _____	
LEFT _____	
DOWNSPOUT _____	
OUTLETS _____	
ELBOWS _____	
OFFSETS _____	
2" _____	
4" _____	
6" _____	
MITERS _____	
STRIP IS _____	
STRIP OS _____	
BAY IS _____	
BAY OS _____	
BOX IS _____	
BOX OS _____	
HANGERS _____	
FLASHING _____	
WEDGES _____	
DIVERTER _____	

PAYMENT TERMS _____ SUB TOTAL \$ _____
 SPECIAL TERMS _____
 CREDIT CARD NO. _____ - _____ - _____ - _____ EXP DATE _____ SALES TAX \$ _____
MM/DD/YYYY
 NAME ON CARD _____ TOTAL \$ _____
 BILLING ZIP CODE _____ BALANCE: CHARGE CREDIT CARD/CHECK _____ LESS DEPOSIT \$ _____
 JOB READY TO INSTALL? Y N MISC. NOTES _____ BALANCE DUE \$ _____

CUSTOMER SIGNATURE _____ PRINTED NAME _____ DATE _____
MM/DD/YYYY



Serving the Seamless Gutter Industry Since 1972

15409 Long Vista Drive
Austin, TX 78728

Phone: 866-522-1696
Fax: 800-295-2702

www.senox.com
senoxinfo@senox.com