

SPANGORX[®]

Proudly Serving the Seamless Gutter Industry Since 1972



2022 Product Catalog

PAINT & METAL SELECTION

Backed By Senox's 50 Year Paint Warranty

TRADITIONAL PAINTED ALUMINUM

Factory Baked Finish • Flexible for Roll Forming • Exterior Durability



Colors shown may vary from actual material

ArmerTOUGH PAINTED ALUMINUM

Exclusive Product • Abrasion Resistant • Reduces Appearance of Staining



DuelTone® PAINTED ALUMINUM

Created Through a Specialized Two-Coat Process
High Performance Exterior Finish



129 - Rustic Copper

PREMIUM METALS

3/4 Hard 16 oz. Copper
26 ga. Galvalume Plus Steel

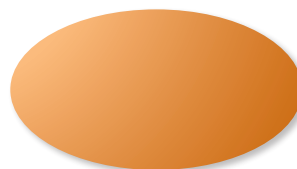

890 - Solid Copper



920 - Galvalume Plus Steel

ShadowBAK
wash coat®
Non-Reflective Disappearing Wash Coat

Found on the Interior of Senox Painted Aluminum Gutters

ShadowBAK® is a washcoat specially formulated by Senox that gives the inside of the gutter a non-reflective finish. The anodized bronze appearance provides the vanishing properties of a black shadow and erases the transition lines from the gutter to the roof.

TABLE OF CONTENTS

COIL Seamless Gutter Coil	p.4	PAINT & SEALANT Touch-Up Paint Sealant - Nitrile Rubber Base Sealant - Tripolymer Base Sealant - SBR Rubber Base	p.18
GUTTER End Caps for K-Style Miters for K-Style	p.4		
Outlets for Flat Bottom Gutter Black MAX® Punch Paks for Flat Bottom Gutter Black MAX® Mini Punch Paks for Flat Bottom Gutter Black MAX® Punch Replacement Accessories	p.5	TOOLS Aviation Snips Offset Snips Regular Pattern Snips Straight Snips Circular "Duckbill" Snips Combination Snips End Cap Crimpers Downspout Crimpers	p.19
Flashing 16 oz. Solid Copper Flat Sheets Gutter Wedges for K-Style	p.6		
DOWNSPOUT Rectangular Downspouts Rectangular Elbows Rectangular Offsets	p.7	Hand Seamers Drivers, Leveling & Caulking Cutting & Drilling	p.20
Round Downspouts Round Elbows Round Offsets	p.8	Ladder Accessories Miscellaneous Accessories Joints	p.21
Downspout Drive, Rack, & Key Downspout Hangers	p.9	RAIN CHAINS Rain Chains	p.22
K-STYLE HANGERS K-Style Internal Hangers	p.10	CONDUCTOR HEADS Conductor Heads Special Order Accessories	p.23
HALF ROUND GUTTER Reverse Bead Half Round Gutter Sections End Caps for Half Round Miters for Half Round Outlets for Half Round Black MAX® Mini Punch Pak for Half Round Gutter Wedges for Reverse Bead Half Round	p.12	GUTTER MACHINES Barracuda® Gutter Machines Barracuda® Gutter Machine Options	p.24
Reverse Bead Half Round Internal Hangers Half Round External Hangers	p.13	Senox Licensed Products	p.25
GUTTER GUARDS Aluminum Expanded Wire Gutter Guard Powder Coated Expanded Wire Gutter Guard Perforated Gutter Guard	p.14	INDEX	p.27
Stainless Steel Metal Mesh Gutter Guard Louvered Gutter Guard Solid Gutter Guard	p.15		
DRAINAGE Splash blocks FLEX-Drain® Underground Drainage & Adaptors Universal Drainage & Adaptors	p.16		
FASTENERS Rivets #42 x 1/8" #8 Screws Senox SpeedMaster™ Screws Nails, Drive Pins, & Anchors	p.17		



Serving the Seamless Gutter Industry Since 1972

LARGEST INVENTORY IN-STOCK

- Complete 5" & 6" K-Style and 6" Half Round product lines
- Dependable order fulfillment & delivery

COMPREHENSIVE COLOR SELECTION

- 26 Painted aluminum colors, galvalume plus steel, & solid copper
- 3 Exclusive Armor Tough® painted aluminum colors
- Exclusive Duel Tone painted aluminum color
- All backed by Senox's 50 year paint warranty

GUTTER ACCESSORIES

- Hidden hangers and half round internal & external hangers
- Outlets, offsets, miters, conductor heads, & more

HIGHEST QUALITY PRODUCTS

- State-of-the-art manufacturing equipment ensures products are of the highest quality
- Senox manufactured products are made in North America

SUPERIOR PACKAGING

- High grade cardboard used for all boxes
- Packaging specific to each product, no excess space for product to shift
- Boxes are sealed using staples vs. tape

- GUTTER MACHINES** • Comprehensive gutter machine service
- 3 Year parts & 1 year electrical warranty on all Senox gutter machines

"We service the seamless gutter industry. That's all we do. If it has to do with gutters, we're either doing it, thinking about doing it, or planning to do it. We're thinking about gutters all the time."

—A.B. Walters, Founder/President



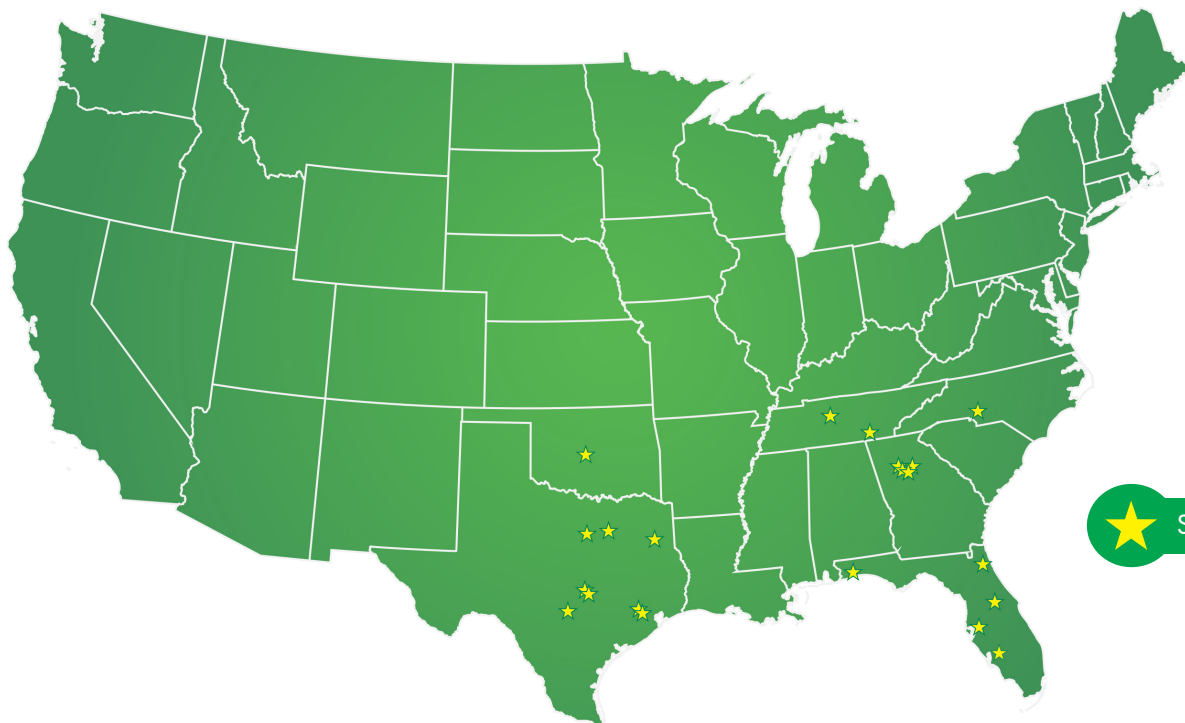

SENOX BRANCH LOCATIONS

E-COMMERCE

www.SenoxOnline.com
Ph: 800-722-6958
Fax: 888-804-4035

REGION 1

AUSTIN

12112 Boardwalk Dr. STE-B
Austin, TX 78729
Ph: 512-582-1331
Fax: 512-582-1333

DALLAS

12925 Valley Branch Ln.
Farmers Branch, TX 75234
Ph: 972-243-7272
Fax: 972-243-7273

FORT WORTH

5204-D Airport Fwy.
Fort Worth, TX 76117
Ph: 817-831-4900
Fax: 817-831-4901

GARLAND

3301 Wood Dr Ste #400
Garland, TX 75041
Ph: 469-573-2233
Fax: 469-573-2204

HOUSTON CENTRAL

4466 W 12th St.
Houston, TX 77055
Ph: 713-316-9802
Fax: 713-316-9807

HOUSTON NORTH

100 Northpark Central Dr.
#400
Houston, TX 77073
Ph: 281-443-0420
Fax: 281-443-0490

LONGVIEW

808-B Jordan Valley Rd.
Longview, TX 75604
Ph: 903-295-9555
Fax: 903-295-9797

OKLAHOMA CITY

1340 Metropolitan Ave.
Oklahoma City, OK 73108
Ph: 405-948-7464
Fax: 405-948-6287

SAN ANTONIO

3816 Binz-Engelman Rd.
B-111
San Antonio, TX 78218
Ph: 210-514-1173
Fax: 210-514-1175

REGION 2

CHATTANOOGA

3475-C 8th Ave.
Chattanooga, TN 37407
Ph: 423-698-0050
Fax: 423-698-3146

FULTON

555-C Wharton Circle
Atlanta, GA 30336
Ph: 404-691-9400
Fax: 404-691-0094

KENNESAW

3690 Kennesaw S. Ind. Dr.
Kennesaw, GA 30144
Ph: 770-795-8500
Fax: 770-795-9991

LOUISVILLE

4850 Crittenden Drive
Suite 1A
Louisville, KY 40209
Ph: 502-324-1860
Fax: 502-325-1300

NASHVILLE

302 Space Park Dr. S.
Nashville, TN 37211
Ph: 615-333-3383
Fax: 615-333-3374

SUWANEE

2970 Shawnee Ridge Ct.
#200
Suwanee, GA 30024
Ph: 770-476-4141
Fax: 770-476-4175

TUCKER*

4662 North Royal Atlanta Dr.
Tucker, GA 30084
Ph: 404-292-6181
Fax: 404-292-6521

REGION 3

FORT MYERS

6361 Topaz Court
Fort Myers, FL 33966
Ph: 239-217-6303
Fax:

JACKSONVILLE

6858 Phillips Parkway Dr. S.
Jacksonville, FL 32256
Ph: 904-880-2192
Fax: 904-880-7256

ORLANDO

473 Presidents Dr.
Orlando, Florida 32809
Ph: 407-734-2148
Fax: 407-369-4229

PENSACOLA

3855 N Palafox St
Pensacola, FL 32505
Ph: 850-701-8192
Fax: 850-303-2682

TAMPA

201-C Kelsey Ln.
Tampa, Florida 33619
Ph: 813-623-6178
Fax: 813-626-1306

REGION 4

CHARLOTTE

1419 Ameron Dr.
Charlotte, NC 28206
Ph: 704-371-5043
Fax: 704-371-5077

*Formerly Clarkston

SEAMLESS GUTTER COIL

Senox seamless gutter coil is available in painted aluminum (all 26 traditional Senox colors), copper, or galvalume+ (all painted coil comes backed by our 50 year paint warranty.)

11 7/8"
 .027" Aluminum
 part # 1111950XXX

15"
 .027" Aluminum
 part # 1115050XXX

Available in: 26 Traditional, 1 Duel Tone®, 3 Armor Tough®

11 7/8"
 .032" Aluminum
 part # OS11119710XXX

15"
 .032" Aluminum
 part # OS11150710XXX

Available in: 26 Traditional, 1 Duel Tone®, 3 Armor Tough®

11 7/8"
 16 oz. Solid Copper
 part # 1111951890

 26 ga. Galvalume Plus Steel
 part # 1111950920

15"
 16 oz. Solid Copper
 part # 1115051890

 26 ga. Galvalume Plus Steel
 part # 1115050920

18"
 .032" Aluminum
 part # OS11180710XXX

18"
 16 oz. Solid Copper
 part # 1118051890

 26 ga. Galvalume Plus Steel
 part # 1118050920



END CAPS FOR K-STYLE

Packaged 25R/25L Units/Box

Senox end caps provide a tap on fit to easily close the ends of the gutter; uses painted Senox coil to ensure a perfect match every time.

5" Right or Left
 right - part # 2215030XXX
 left - part # 2215050XXX

6" Right or Left
 right - part # 2216030XXX
 left - part # 2216050XXX

7" Right or Left
 right - part # 2217030XXX
 left - part # 2217050XXX

Available in: 26 Traditional, 1 Duel Tone® (129), 3 Armor Tough®, 16 oz. Solid Copper (890), 26 ga. Galvalume Plus Steel (920)

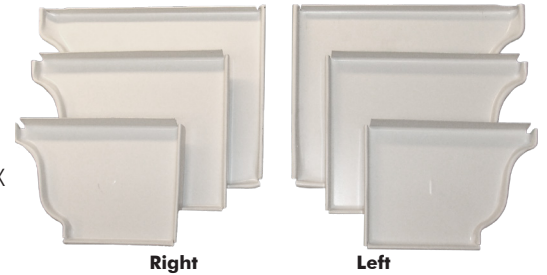

MITERS FOR K-STYLE

Packaged 20 Units/Box

The fastest way to install corners, and available in the full range of Senox colors to perfectly match Senox gutters.

5", 90°, Strip, O/S or I/S
 O/S - part # 2315110XXX
 I/S - part # 2315130XXX

6", 90°, Strip, O/S or I/S
 O/S - part # 2316110XXX
 I/S - part # 2316130XXX

7", 90°, Strip, O/S or I/S
 O/S - part # 2317110XXX
 I/S - part # 2317130XXX

5", 45°, Bay, O/S or I/S
 O/S - part # 2315310XXX
 I/S - part # 2315330XXX

6", 45°, Bay, O/S or I/S
 O/S - part # 2316310XXX
 I/S - part # 2316330XXX

7", 45°, Bay, O/S or I/S
 O/S - part # 2317310XXX
 I/S - part # 2317330XXX

5", 90°, Box, O/S or I/S
 O/S - part # 2315610XXX
 I/S - part # 2315630XXX

6", 90°, Box, O/S or I/S
 O/S - part # 2316610XXX
 I/S - part # 2316630XXX

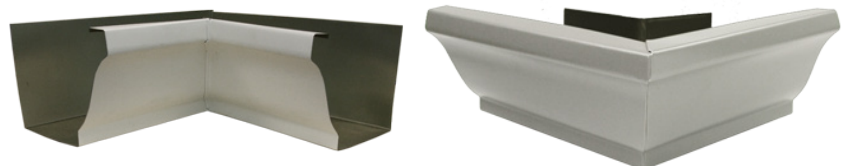

Available in: 26 Traditional, 1 Duel Tone®, 3 Armor Tough®, 16 oz. Solid Copper (890), 26 ga. Galvalume Plus Steel (920)

COLOR SELECTION

Traditional Painted Aluminum

- 001 30° White
- 002 Royal Brown
- 003 Antique Ivory
- 004 Black
- 005 Raffia Beige
- 006 Beaver Brown
- 007 Classic Cream
- 008 Clay
- 009 Colonial Blue
- 010 Sherwood Green
- 011 Musket Brown
- 013 Wicker
- 014 Dove Gray
- 015 Almond
- 017 Linen
- 018 Light Bronze
- 019 Tuxedo Gray
- 020 Heritage Cream

- 021 Colonial Gray
- 022 Buckskin Brown
- 023 80° White
- 024 Colonial Red
- 025 Dark Bronze
- 026 Herringbone
- 027 Copper Metallic
- 028 Paint Grip Metallic

Duel Tone® Painted Aluminum

- 129 Rustic Copper

Armor Tough® Painted Aluminum

- 130 Satin White
- 131 Wood Beige
- 132 Cameo

Metal Selection

- 099 Mill Finish Aluminum
- 870 Brass
- 890 Solid Copper
- 910 Galvanized Steel
- 920 Galvalume Plus Steel
- 968 Copper Plus

OUTLETS FOR FLAT BOTTOM GUTTER

Senox outlets include an exclusive dimple for easy 'pop in' installation when used in tandem with our outlet punch- helps provide a snug fit when installing the outlet in the bottom of the gutter.

2 3/8" Round
250 pcs/box
part # 2612110004



Available in: Black (004)

2 3/4" Round
250 pcs/box
part # 2613110004



3" Oval
100 pcs/box
part # 263311XXXX



Available in: Black (004), Solid Copper (890), Galv Steel (910)

4" Oval
50 pcs/box
part # 263411XXXX



2" x 3" Rectangle
100 pcs/box
part # 2643110004



Available in: Black (004)

3" x 4" Rectangle
50 pcs/box
part # 2644120004



4" x 5" Rectangle
50 pcs/box
part # 2645140XXX



Available in: Aluminum (099), Solid Copper (890), Galv Steel (910)

BLACK MAX® PUNCH PAKS FOR FLAT BOTTOM GUTTER

Everything you need to install the best gutter outlets anywhere; the Punch Pak includes Punch, 1 1/2" Hole Saw, 1/4" Driver Power Bit, and outlets- all for the same price as just ordering the outlets by themselves!

2 3/8" Round
750 Outlets
part # 2612119004

2 3/4" Round
750 Outlets
part # 2613119004

2" x 3" Rectangle
900 Outlets
part # 2643119004

3" Oval
900 Outlets
part # 2633119004

4" Oval
450 Outlets
part # 2634119004

3" x 4" Rectangle
450 pcs/box
part # 2644129004

Includes: Punch, 1 1/2" Hole Saw, 1/4" Driver Power Bit, Outlets



BLACK MAX® MINI PUNCH PAKS FOR FLAT BOTTOM GUTTER

If you're just doing a job or two and don't need as many outlets as our standard Punch Pak, you need the Mini Punch Pak. Includes Punch, 1 1/2" Hole Saw, 1/4" Driver Power Bit, and outlets.

2 3/8" Round
35 Outlets
part # 2612118004

2 3/4" Round
35 Outlets
part # 2613118004

2" x 3" Rectangle
100 Outlets
part # 2643118004

3" Oval
100 Outlets
part # 2633118004

4" Oval
50 Outlets
part # 2634118004

3" x 4" Rectangle
50 pcs/box
part # 2644128004

Includes: Punch, 1 1/2" Hole Saw, 1/4" Driver Power Bit, Outlets



BLACK MAX® PUNCH REPLACEMENT ACCESSORIES

Hole Saw 1 1/2", for Punch
part # 8926928



Driver Bit 1/4", for Punch
part # 8950812



FLASHING

No fasteners needed; Senox Drip Caps help keep water from running behind the gutter, protecting your customer's roof.

Drip Cap

30 pcs/box
4' - part # 291812XXX

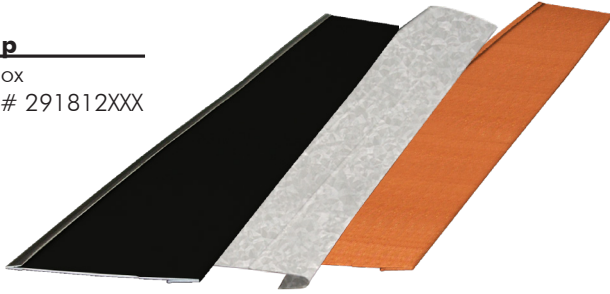

Available in: Black (004), 16 oz. Solid Copper (890),
26 ga. Galvalume Plus Steel (920)

Senox Drip Edges have the largest color selection in the marketplace today- available in all Senox colors.

Drip Edge, 1 1/2" x 1 1/2"

30 pcs/box - Aluminum
15 pcs/box - Copper, Steel
10' - part # 2910150XXX

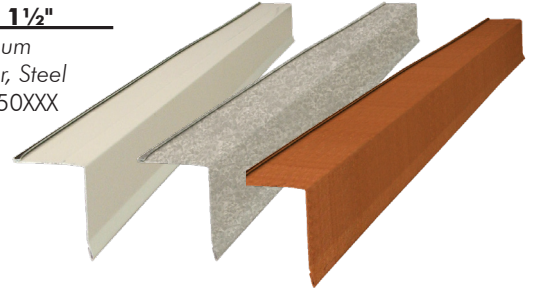

Available in: 26 Traditional, 1 Duel Tone®(129), 3 Armor Tough®,
16 oz. Solid Copper (890), 26 ga. Galvalume Plus Steel (920)

16 OZ. SOLID COPPER FLAT SHEETS

3' x 10'

36 units/pallet
part # 133655890



GUTTER BUMPERS FOR K-STYLE

Compared to traditional gutter wedges, Senox Gutter Bumpers are faster & more cost effective- and with premarked lines, cutting accurately is easier than ever. All our bumpers feature ribs to provide extra strength and the SB bumper also fits 5", 6", & 7" K-Style gutters, unlike traditional wedges which you buy to size.

Gutter Bumper® SB

100 pcs/box
part # 2928150XXX

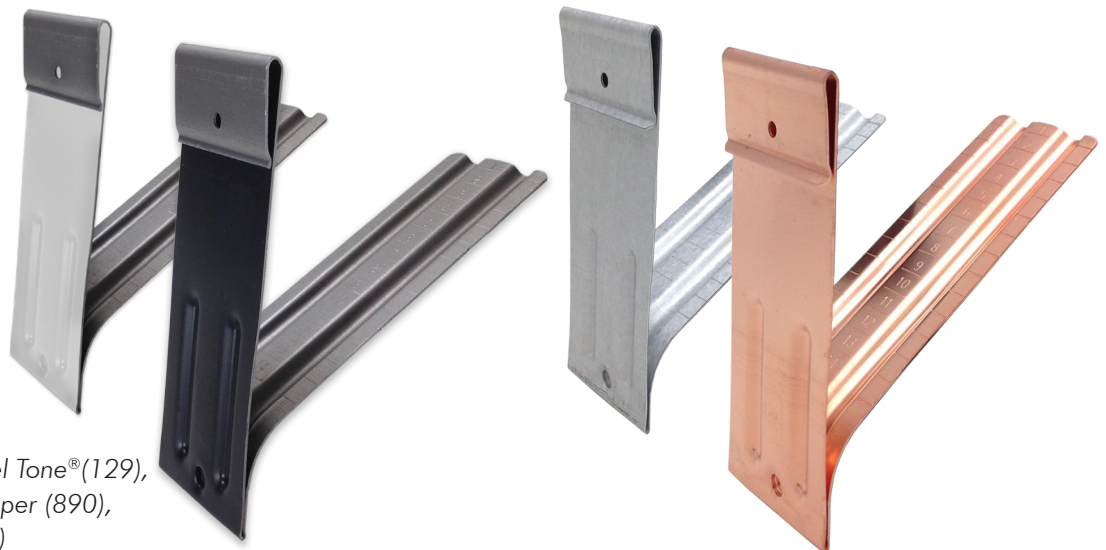

Available in: 26 Traditional, 1 Duel Tone®(129),
3 Armor Tough®, 16 oz. Solid Copper (890),
26 ga. Galvalume Plus Steel (920)

**For Straight Back
Gutter**

RECTANGULAR DOWNSPOUTS

Senox rectangular downspouts feature side crimp instead of the usual corner crimp, which allows for a cleaner transition.

2" x 3" x 8'

10 units/box
part # 4143240XXX

3" x 4" x 8'

10 units/box
part # 4144240XXX

Available in: 26 Traditional, 1 Duel Tone®, 3 Armor Tough®

2" x 3" x 10'

10 units/box - Aluminum
5 units/box - Copper & Steel
part # 4143250XXX

3" x 4" x 10'

10 units/box - Aluminum
5 units/box - Copper & Steel
part # 4144250XXX

4" x 5" x 10'

6 units/box
part # 4145250XXX

Available in: 26 Traditional, 1 Duel Tone® (129), 3 Armor Tough®, 16 oz. Solid Copper (890), 26 ga. Galvalume Plus Steel (920)



RECTANGULAR ELBOWS

2" x 3", A or B, 75°

36 pcs/box
A - part # 4243270XXX
B - part # 4243770XXX

3" x 4", A or B, 75°

20 pcs/box
A - part # 4244270XXX
B - part # 4244770XXX

4" x 5", A or B, 75°

12 pcs/box
A - part # 4245270XXX
B - part # 4245770XXX

2" x 3", A, 22.5°

72 pcs/box
part # 42432200XXX

3" x 4", A, 22.5°

40 pcs/box
part # 42442200XXX

4" x 5", A, 22.5°

12 pcs/box
part # 42452200XXX

2" x 3", A, 45°

42 pcs/box
part # 42432400XXX

3" x 4", A, 45°

30 pcs/box
part # 42442400XXX

4" x 5", A, 45°

12 pcs/box
part # 42452400XXX

Available in: 26 Traditional, 1 Duel Tone® (129), 3 Armor Tough®, 16 oz. Solid Copper (890), 26 ga. Galvalume Plus Steel (920)

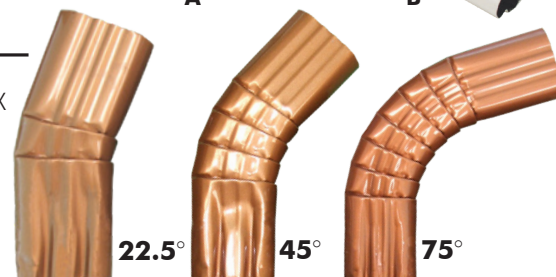

RECTANGULAR OFFSETS

2" x 3" x 2"

24 pcs/box
part # 4343220XXX

2" x 3" x 4"

24 pcs/box
part # 4343240XXX

2" x 3" x 6"

24 pcs/box
part # 4343260XXX

3" x 4" x 2"

15 pcs/box
part # 4344220XXX

3" x 4" x 4"

15 pcs/box
part # 4344240XXX

3" x 4" x 6"

15 pcs/box
part # 4344260XXX

Available in: 26 Traditional, 1 Duel Tone® (129), 3 Armor Tough®, 16 oz. Solid Copper (890), 26 ga. Galvalume Plus Steel (920)



MADE TO ORDER

If you need a less common bend, we've got you covered!
Custom bend elbows are available upon request.

2" x 3", A or B, 90°

36 pcs/box
A - part # 424329XXX
B - part # 424379XXX

3" x 4", A or B, 90°

18 pcs/box
A - part # 424429XXX
B - part # 424479XXX

2" x 3", B, 45°

42 pcs/box
part # 424374XXX

3" x 4", B, 45°

25 pcs/box
part # 424474XXX

Available in: 30° White (001)

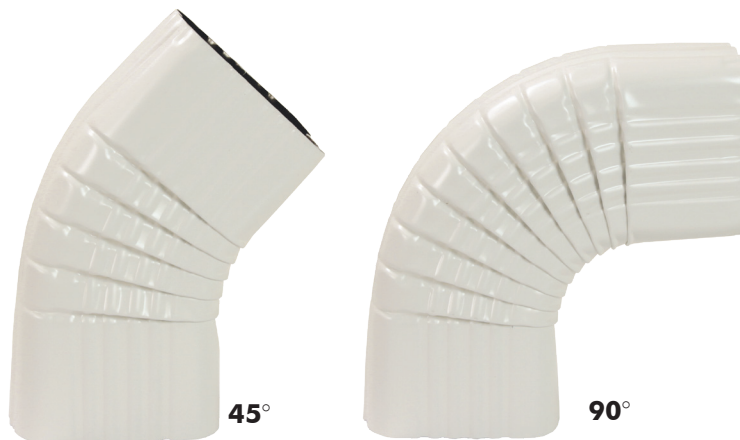

ROUND DOWNPOUTS

Packaged 5 Units/Box

Available in every Senox color, Senox round downspouts are the perfect compliment to our Half Round gutters (and offer a different option for K-Style gutters, too!)

3" x 10' Round
part # 4153250XXX

4" x 10' Round
part # 4154250XXX

Available in: 26 Traditional, 1 Duel Tone® (129), 3 Armor Tough®, 16 oz. Solid Copper (890), 26 ga. Galv Steel (920)



ROUND ELBOWS

3" Round, 75°
10 units/box
part # 4253270XXX

4" Round, 75°
10 units/box
part # 4254270XXX

3" Round, 22.5°
12 units/box
part # 4253220XXX

4" Round, 22.5°
12 units/box
part # 4254220XXX

3" Round, 45°
12 units/box
part # 4253240XXX

4" Round, 45°
10 units/box
part # 4254240XXX

Available in: 26 Traditional, 1 Duel Tone®, 3 Armor Tough®, 16 oz. Solid Copper, 26 ga. Galvalume Plus Steel

3" Round, 90°
8 units/box
part # 4253290XXX

4" Round, 90°
8 units/box
part # 4254290XXX

Available in: 30° White (001), 16 oz. Solid Copper (890), 26 ga. Galvalume Plus Steel (920)



22.5°



45°



75°

ROUND OFFSETS

3" Round x 2"
6 pcs/box
part # 4353220XXX

3" Round x 4"
6 pcs/box
part # 4353240XXX

3" Round x 6"
4 pcs/box
part # 4353260XXX

4" Round x 2"
4 pcs/box
part # 4354220XXX

4" Round x 4"
4 pcs/box
part # 4354240XXX

4" Round x 6"
4 pcs/box
part # 4354260XXX

Available in: 26 Traditional, 1 Duel Tone® (129), 3 Armor Tough®, 16 oz. Solid Copper (890), 26 ga. Galvalume Plus Steel (920)



DOWNSPOUT ACCESSORIES

2" Round Elbow

1 unit/box
part # OS4252370001



Available in: 30° White (001)

Scupper

1 pcs/box
part # 496770001



DOWNSPOUT HANGERS

Available in all Senox colors, Quarter Moon hangers give a decorative finish to your downspout installations.

Quarter Moon for Rectangular

For 2"X3" and 3"X4"
100 units/box
part # 4540650XXX



Quarter Moon for Round

For 3" and 4"
100 units/box
part # 4541650XXX



Available in: 26 Traditional, 1 Duel Tone® (129), 3 Armor Tough®, 16 oz. Solid Copper (890), 26 ga. Galvalume Plus Steel (920)

Concealed for Rectangular

For 2"X3" and 3"X4"
100 units/box
part # 4535550XXX

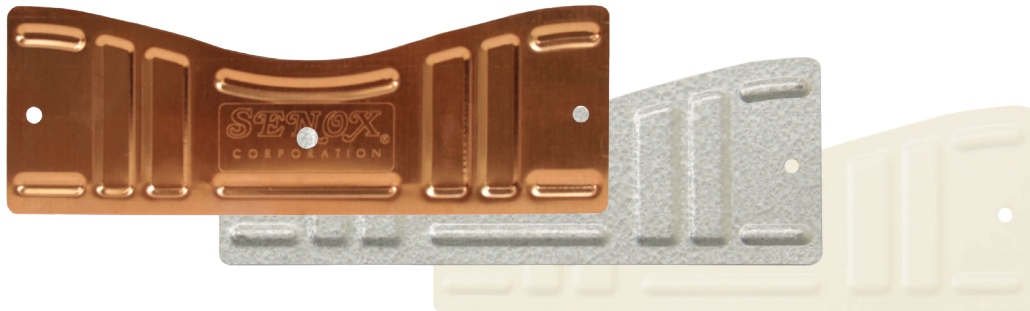

Available in: 26 Traditional, 1 Duel Tone® (129), 3 Armor Tough®, 16 oz. Solid Copper (890), 26 ga. Galvalume Plus Steel (920)

K-STYLE INTERNAL HANGERS

1600 Series for 5", 6"

Aluminum .060 with or without clip

Our most economical .060 robust hanger (but still built to Senox's high standards)

100 pcs/box - Aluminum

5", no clip - part # 2416501099

5", w/clip - part # 2416531099

6", no clip - part # 2416601099

6", w/clip - part # 2416631099

Mini-barrels - Aluminum

5", no clip - 1000 pcs - part # 2416504099

5", w/clip - 1000 pcs - part # 2416534099

6", no clip - 500 pcs - part # 2416603099

6", w/clip - 500 pcs - part # 2416633099

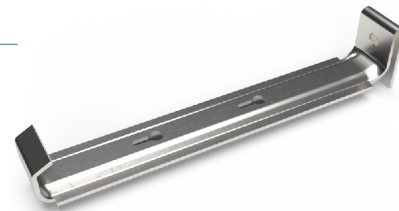

1800 Series for 5", 6"

Aluminum .047 with or without clip

The most cost efficient way to eliminate gutter rattle

100 pcs/box - Aluminum

5", no clip - part # 2418501099

5", w/clip - part # 2418531099

6", no clip - part # 2418601099

6", w/clip - part # 2418631099

Mini-barrels - Aluminum

5", no clip - 1000 pcs - part # 2418504099

5", w/clip - 1000 pcs - part # 2418534099

6", no clip - 500 pcs - part # 2418603099

6", w/clip - 500 pcs - part # 2418633099



2100 Series for 5", 6"

Aluminum .060 with or without clip

Our top seller! Senox's strongest hanger to come without a pre-loaded screw.

100 pcs/box - Aluminum

5", no clip - part # 2421501099

5", w/clip - part # 2421531099

6", no clip - part # 2421601099

6", w/clip - part # 2421631099

Mini-barrels - Aluminum

5", no clip - 1000 pcs - part # 2421504099

5", w/clip - 1000 pcs - part # 2421534099

6", no clip - 500 pcs - part # 2421603099

6", w/clip - 500 pcs - part # 2421633099



2300 Series for 5", 6"

Aluminum .047 with or without clip

Copper and Galvalume+ .047 with or without clip

A wider hanger, comes with 3 pre-drilled holes (so breaking a screw is no big deal!)

100 pcs/box - Aluminum, Solid Copper, Galv Steel

5", no clip - part # 2423501XXX

5", w/clip - part # 2423531XXX

6", no clip - part # 2423601XXX

6", w/clip - part # 2423631XXX

Mini-barrels - Aluminum

5", no clip - 500 pcs - part # 2423503099

5", w/clip - 500 pcs - part # 2423533099

6", no clip - 250 pcs - part # 2423602099

6", w/clip - 250 pcs - part # 2423632099

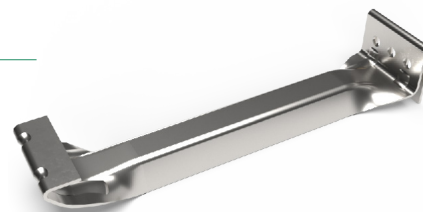

2800 Series for 5", 6"

Aluminum .047 with or without clip, #10 x 1.5" screw with T17 point, hi-low thread, 1000 hour black ruspert

Copper .050 with or without clip, #10 x 1.5" screw with T17 point, hi-low thread, stainless steel

Galv. Steel .047 with or without clip, #10 x 1.5" screw with T17 point, hi-low thread, 1000 hour black ruspert

Comes with Rattler™ front lip, and preloaded with 1.5" screw and washer for convenience.

100 pcs/box - Aluminum, Solid Copper

5", no clip - part # 2428501XXX

5", w/clip - part # 2428531XXX

6", no clip - part # 2428601XXX

6", w/clip - part # 2428631XXX

Mini-barrels - Aluminum

5", no clip, 500 pcs - part # 2428503099

5", w/clip, 500 pcs - part # 2428533099

6", no clip, 250 pcs - part # 2428602099

6", w/clip, 250 pcs - part # 2428632099



100 pcs/box - Galv Steel

5", no clip - part # 2428501920

5", w/clip - part # 2428531920

6", no clip - part # 2428601920

6", w/clip - part # 2428631920

2900 Series for 5", 6"

Aluminum .047 with or without clip, #10 x 2" screw with T17 point, hi-low thread, 1000 hour black ruspert

Copper .050 with or without clip, #10 x 2" screw with T17 point, hi-low thread, stainless steel

Galv. Steel .047 with or without clip, #10 x 2" screw with T17 point, hi-low thread, 1000 hour black ruspert

Comes with Rattler® front lip, and preloaded with 2" screw for convenience.

100 pcs/box - Aluminum, Solid Copper, Galv Steel

5", no clip - part # 2429501XXX

5", w/clip - part # 2429531XXX

6", no clip - part # 2429601XXX

6", w/clip - part # 2429631XXX

Mini-barrels - Aluminum

5", no clip, 500 pcs - part # 2429503099

5", w/clip, 500 pcs - part # 2429533099

6", no clip, 250 pcs - part # 2429602099

6", w/clip, 250 pcs - part # 2429632099



K-STYLE INTERNAL HANGERS

3400 Series for 5", 6"

Aluminum .047 with or without clip, #10 x 3" screw with T17 point, hi-low thread, 1000 hour black ruspert

Strong & Convenient, comes preloaded with 3" screw.

100 pcs/box - Aluminum

5", no clip - part # 2434551099

5", w/clip - part # 2434571099

6", no clip - part # 2434651099

6", w/clip - part # 2434671099

Mini-barrels - Aluminum

5", no clip, 500 pcs - part # 2434553099

5", w/clip, 500 pcs - part # 2434573099

6", no clip, 250 pcs - part # 2434652099

6", w/clip, 250 pcs - part # 2434672099



3600 Series for 5", 6"

Aluminum .047 with or without clip, #12 x 3" screw with T17 point, hi-low thread, 1000 hour black ruspert

Strong & Convenient, comes preloaded with #12 screw.

100 pcs/box - Aluminum

5", no clip - part # 2436551099

5", w/clip - part # 2436571099

6", no clip - part # 2436651099

6", w/clip - part # 2436671099

Mini-barrels - Aluminum

5", no clip, 500 pcs - part # 2433553099

5", w/clip, 500 pcs - part # 2433573099

6", no clip, 250 pcs - part # 2433652099

6", w/clip, 250 pcs - part # 2433672099



3800 Series for 5", 6"

Aluminum .047, wider, with or without clip, #12 x 3" screw with T17 point, hi-low thread, 1000 hour black ruspert

A more robust version of the 3600 hanger, comes preloaded with #12 screw.

100 pcs/box - Aluminum, Solid Copper, Galvanized Steel

5", no clip - part # 2438551099

5", w/clip - part # 2438571XXX

6", no clip - part # 2438651099

6", w/clip - part # 2438671XXX



3800 Series for 7"

Copper .050, with or without clip, #12 x 3" screw with T17 point, hi-low thread, stainless steel

Galv. Steel .050, with or without clip, #12 x 3" screw with T17 point, hi-low thread, 1000 hour black ruspert

A more robust 7" version of the 3600 hanger, comes preloaded with #12 screw.

100 pcs/box - Solid Copper, Galvanized Steel

7", no clip - part # 2438771XXX

7", w/clip - part # 2438771XXX



4000 Series for 5", 6"

Aluminum .055, with or without clip, #12 x 3.5" screw with T17 point, hi-low thread, 1000 hour black ruspert

Copper .050, with clip, #12 x 3.5" screw with T17 point, hi-low thread, stainless steel

Our strongest hanger, comes preloaded with #12 screw.

100 pcs/box - Aluminum, Solid Copper

5", no clip - part # 2440551099

5", w/clip - part # 2440571099 | 2440571890

6", no clip - part # 2440651099 | 2440651890

6", w/clip - part # 2440671099 | 2440671890

Mini-barrels - Aluminum

5", no clip, 500 pcs - part # 2440553099

5", w/clip, 500 pcs - part # 2440573099

6", no clip, 250 pcs - part # 2440652099

6", w/clip, 250 pcs - part # 2440672099



4200 Series for 7"

Aluminum .060, with or without clip, #12 x 3" screw with T17 point, twin lead thread, 1000 hour black ruspert

7", .060 thick version of the 3800 hanger- Strong & Convenient, comes preloaded with #12 screw.

100 pcs/box - Aluminum

7", no clip - part # 2442761099

7", w/clip - part # 2442771099



9700 Series for 5", 6"

100 pcs/box - Aluminum

5", Vampire, w/strap - part # 2441511099

6", Vampire, w/strap - part # 2441611099



9000 Series

100 pcs/box - Aluminum, Solid Copper (890), Stainless Steel

10" T-Strap - part # 2499001XXX

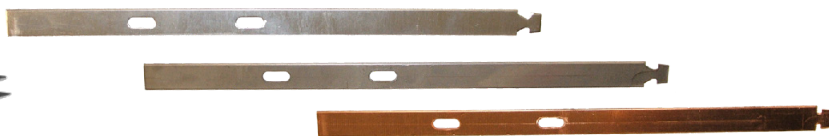

REVERSE BEAD HALF ROUND INTERNAL HANGERS

5000 Series for 6"HR

Aluminum .060 with or without clip

100 pcs/box - Aluminum
6", w/clip - part # 2450631099
6", no clip - part # 2450611099



Designed specifically for Half Round internal hangers, includes an extended wedge clip that sits against the fascia, preventing the gutter from tipping forward.

5100 Series w/ Wedge for 6"

Aluminum .060, with clip
Copper .050, with clip
Galvalume Plus .040, with clip

100 pcs/box
part # 2451631XXX

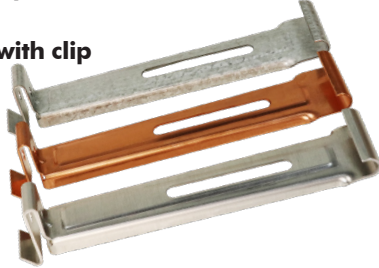

Available in: Aluminum (099), Solid Copper (890), Galvalume Plus (920)

5300 Series w/ Wedge for 6"

Aluminum .060, with or without clip, #12 x 3" screw with T17 point, hi-low thread, 1000 hour black ruspert
Copper .050, with or without clip, #12 x 3" screw with T17 point, hi-low thread, stainless steel
Galv. Steel .050, with or without clip, #12 x 3" screw with T17 point, hi-low thread, 1000 hour black ruspert

100 pcs/box
Aluminum part # 2453661099
Solid Copper part # 2453661890
Galv Steel part # 2453661920



HALF ROUND EXTERNAL HANGERS

6" #10 Combo w/Spring

50 pcs/box
part # 255004XXX



Available in: White (001), Brown (002), Dark Bronze (025), Solid Copper (890), Galv Steel (920)

6" Circle w/Spring, Nut, & Bolt

50 pcs/box
part # 255224XXX



Extra Spring

50 pcs/box
part # 255226XXX



Available in: White (001), Brown (002), Dark Bronze (025), Brass (870), Galv Steel (920)

#6 Shank for OG Crown Molding

50 pcs/box
part # 255106XXX



Available in: Solid Copper (890), Galv Steel (910)

#11 Shank Exposed Rafter 1/3 Pitch

50 units/box
part # 255111XXX



Available in: White (001), Brown (002), Solid Copper (890), Galv Steel (910)

#12 Shank Sheeting 1/3 Pitch

50 pcs/box
part # 255112XXX



#25 Shank Sheeting 1/2 Pitch

50 pcs/box
part # 255115XXX



Available in: Solid Copper (890), Galv Steel (910)

#30 Shank Adjustable Pitch w/Nut & Bolt

50 pcs/box
part # 255116XXX



Available in: White (001), Brown (002), Dark Bronze (025), Solid Copper (890), Galv Steel (910)

5800 Series

25 units/box
part # 2558721XXX



Available in: 26 Traditional, 1 Duel Tone®(129), 3 Armor Tough®, 16 oz. Solid Copper (890), 26 ga. Galvalume Plus Steel (920)

Extra Bolt w/Nut #10/24 x 3/4"

50 units/box
part # 255228XXX



Available in: Brass (870) Galv Steel (910)

Wrap Around w/Strap for 6"

50 units/box
part # 2450631XXX



Available in: Solid Copper (890), Galv Steel (910)

REVERSE BEAD HALF ROUND GUTTER SECTIONS

Packaged 5 Units/Box

Offer your customers specialty gutters without the investment of a dedicated half round machine.



6" x 10'

part # 2166051890

Available in: 16 oz. Solid Copper

Available in: 26 Traditional, 1 Duel Tone® (129), 3 Armor Tough®, 16 oz. Solid Copper (890), 26 ga. Galvalume Plus Steel (910)

END CAPS FOR HALF ROUND

Packaged 25 Units/Box

6" Right or Left

right - part # 2266030XXX
left - part # 2266050XXX



Right



Left

Available in: 26 Traditional, 1 Duel Tone® (129), 3 Armor Tough®, 16 oz. Solid Copper (890), 26 ga. Galvalume Plus Steel (910)

MITERS FOR HALF ROUND

Packaged 20 Units/Box

6", 90°, Strip, O/S or I/S

O/S - part # 2366110XXX
I/S - part # 2366130XXX



6", 45°, Bay, O/S or I/S

O/S - part # 2366310XXX
I/S - part # 2366330XXX



Available in: 26 Traditional, 1 Duel Tone® (129), 3 Armor Tough®, 16 oz. Solid Copper (890), 26 ga. Galvalume Plus Steel (910)

OUTLETS FOR HALF ROUND

Packaged 50 Units/Box

3" Round

part # 265364XXXX

Available in: White (001), Solid Copper (890), Galv Steel (910)



4" Half Round

part # 265444XXXX

Available in: 30° White (001), Black (004), Solid Copper (890), Galv Steel (910)



BLACK MAX® MINI PUNCH PAK FOR HALF ROUND

Everything you need to install half round outlets; the Mini Punch Pak includes Punch, 1 1/2" Hole Saw, 1/4" Driver Power Bit, and bulk savings on the outlets you need.

4" Half Round

10 Outlets
part # 2654448004

Includes: Punch, 1 1/2" Hole Saw, 1/4" Driver Power Bit, Outlets



GUTTER WEDGES FOR REVERSE BEAD HALF ROUND

Gutter Bumper® HR

100 pcs/box
part # 2928660XXX

Available in: 30° White (001), Black (004), 16 oz. Solid Copper (890), 26 ga. Galvalume Plus Steel (910)

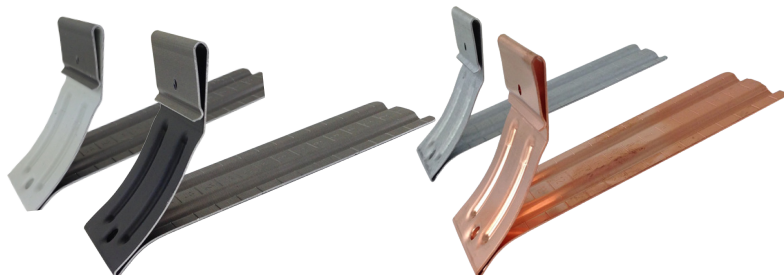

ALUMINUM EXPANDED WIRE GUTTER GUARD

Our most cost effective solution for keeping your customer's gutters debris-free.

Drop-In

4' pcs, 50 pcs/box
5" - part # 3813050099
6" - part # 3813060099

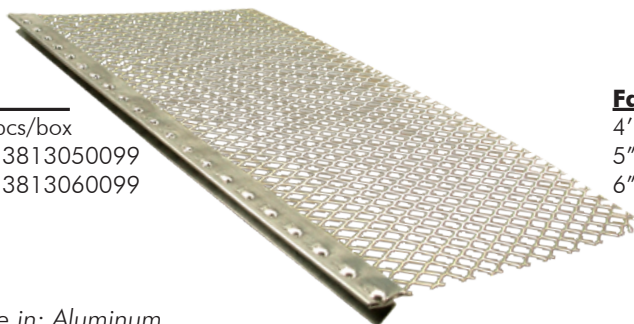

Fast Screen

4' pcs, 50 pcs/box
5" - part # 3815050099
6" - part # 3815060099



Available in: Aluminum

POWDER COATED EXPANDED WIRE GUTTER GUARD

Powder coated galvanized steel provides superior rust, rodent, and debris protection for decades to come.

Roll Lock

4' pcs, 25 pcs/box
5" - part # 3821050XXX
6" - part # 3821060XXX
7" - part # 3821070XXX

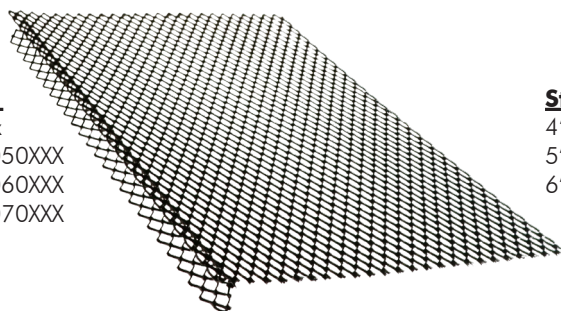

Step Lock

4' pcs, 25 pcs/box
5" - part # 3823050XXX
6" - part # 3823060XXX

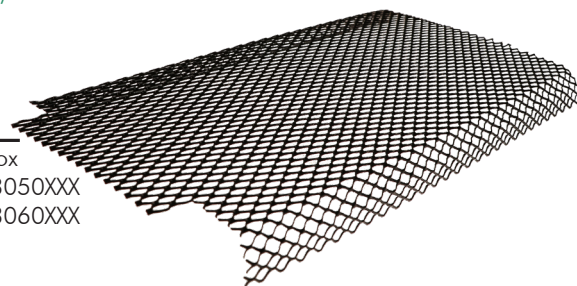

Flat Lock

4' pcs, 25 pcs/box
6" - part # 3825060XXX
7" - part # 3825070XXX
8" - part # 3825080XXX
9" - part # 3825090XXX

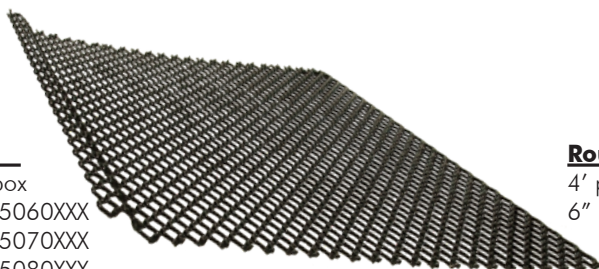

Round Lock for HR 6"

4' pcs, 25 pcs/box
6" - part # 3827060XXX

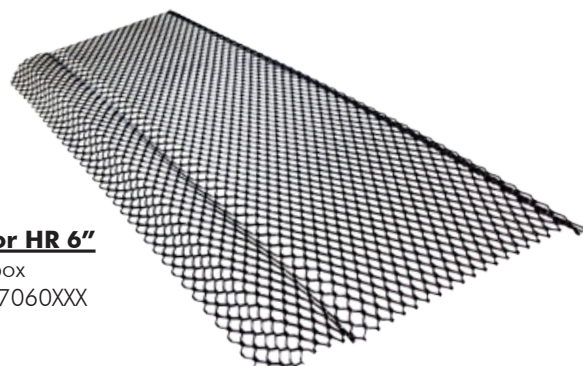

Available in: Black (004), Solid Copper (890)

PERFORATED GUTTER GUARD

Senox perforated gutter guards keep more debris from entering gutters and make cleaning them a breeze.

Eave N Flow

4' pcs, 50 pcs/box
5" - part # 3914050004
6" - part # 3914060004

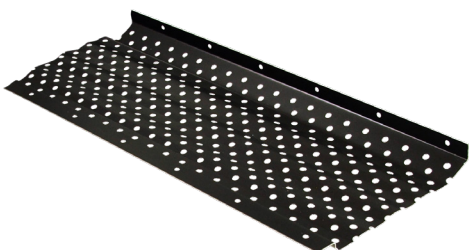

Smart Flow

4' pcs, 50 pcs/box
5" x 4' - part # 3914000XXX
6" x 4' - part # 3914010XXX
10' pcs, 25 pcs/box
5" x 10' - part # 3914100XXX
6" x 10' - part # 3914110XXX
7" x 10' - part # 3914120XXX

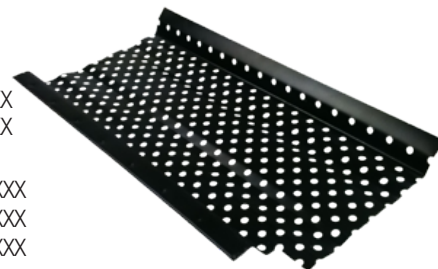

Available in: Black

Available in: White (001), Black (004)

STAINLESS STEEL METAL MESH GUTTER GUARD

For areas with fine debris like pine needles, metal mesh gutter guards provide the ultimate in debris protection.

Mesh Guard

4' pcs, 25 pcs/box
5" - part # 3930050004
6" - part # 3930060004

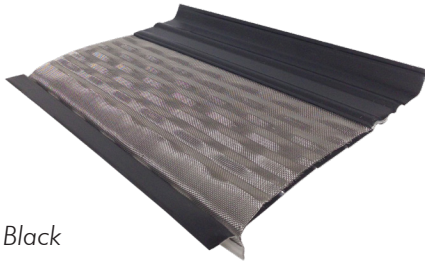

Available in: Black

Mesh Guard Panel

4' pcs, 25 pcs/box
part # 3931050XXX

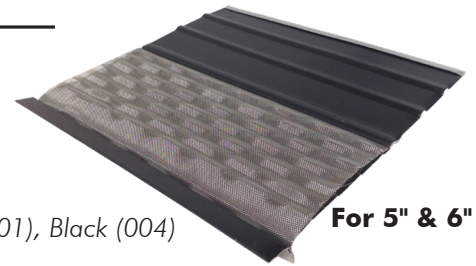

Available in: White (001), Black (004)

For 5" & 6"

LOUVERED GUTTER GUARD

Leaf protection that is as easy to install as it is to clean.

E-Z Leaf Sweep

4' pcs, 25 pcs/box
5" - part # 3924050XXX
6" - part # 3924060XXX

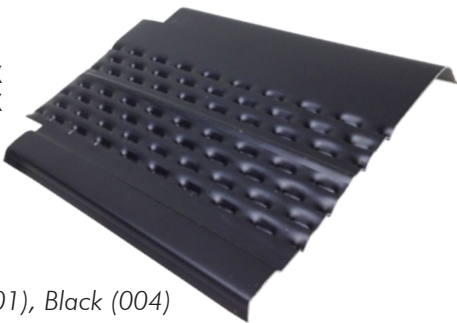

Available in: White (001), Black (004)

E-Z Leaf Protection

4' pcs, 25 pcs/box
part # 3925050XXX



For 5" & 6"

SOLID GUTTER GUARD

Solid gutters guards use surface tension to direct water over the front and into the gutter. Unique patent pending gap system protects the gutter without clogging the outlets.

LeafFree

4' pcs, 25 pcs/box
part # 395215XXX



For 5" & 6"

Leaffree High Water Flow

4' pcs, 5 pcs/box
part # 395225XXX



For 5" & 6"

Available in: 30° White (001), Royal Brown (002), Antique Ivory (003), Black (004), Clay (008), Sherwood Green (010), Musket Brown (011), Wicker (013), Almond (015), Linen (017), Light Bronze (018), Tuxedo Gray (019), Heritage Cream (020), Colonial Gray (021), Colonial Red (024), Dark Bronze (025)

*Solid Copper Special Order

Midwest Solid

4' pcs, 25 pcs/box
5" - part # 395015XXX
6" - part # 395016XXX

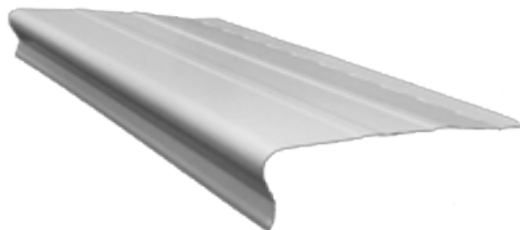

Available in: 30° White (001), Royal Brown (002), Black (004), Clay (008), Wicker (013), Almond (015), Light Bronze (018), Colonial Gray (021)

SPLASH BLOCKS

Plastic, Slate, 10" x 21"

10 units/box
 Gray - part # 612100014
 Tan - part # 612100017



Concrete, 11" x 18"

80 units/pallet
 Gray - part # 611115014



Concrete, 12" x 12"

100 units/pallet
 Gray - part # 611110014



FLEX-DRAIN® UNDERGROUND DRAINAGE & ADAPTORS

Packaged 1 Unit/Box

FLEX-Drain® 4" x 12' Perforated Pipe

part # 622512004



FLEX-Drain® 4" x 25' Solid Pipe

part # 622516004



FLEX-Drain® 4" Coupler

part # 622520004



FLEX-Drain® 4" Flexible T/Y

part # 622525004



FLEX-Drain® 2" x 3" x 4" Downspout Adapter

part # 622522004



FLEX-Drain® 3" x 4" x 4" Downspout Adapter

part # 622524004



Available in: Black

UNIVERSAL DRAINAGE & ADAPTORS

Packaged 1 Unit/Box

2" x 3" DS to 4" Universal

part # 623022004



3" x 4" DS to 4" Universal

part # 623024004



Available in: Black

RIVETS #42 X 1/8"

Packaged 100 Units/Box

A wide selection of colors are available to more effectively blend with Senox gutters.

Aluminum, Painted

part # 521421XXX



Steel, Zinc Plated

part # 521421905



Solid Copper Barrel, Copper Plated Mandrel

part # 521421890



Available in: All Senox colors

#8 SCREWS

1/4" Hex Head, 1/2" 1000 Hour Black Ruspert Coating

100 ct. - part # 511211XXX
1000 ct. - part # 511212XXX



1/4" Hex Head 1/2" Zinc Plated

100 ct. - part # 511211905
1000 ct. - part # 511212905



1/4" Hex Head 1/2" Copper Plated Stainless Steel

100 ct. - part # 511211967



Available in: All Senox colors

SENOX SPEED MASTER® SCREWS

Senox Speed Master® screws are the only ones on the market specifically designed for gutter installation, coated with a long lasting black ruspert finish to better prevent corrosion.

Packaged 250 Units/Bag

#10 x 1 1/2" No Washer, 1000 Hour Black Ruspert Coating

part # 513042904

#10 x 1 1/2" With Washer, 1000 Hour Black Ruspert Coating

part # 513142904

#10 x 2" No Washer, 1000 Hour Black Ruspert Coating

part # 513052904

#10 x 2" With Washer, 1000 Hour Black Ruspert Coating

part # 513152904



Packaged 250 Units/Bag

#10 x 1 1/2" With Washer Stainless Steel

part # 95513144961

#10 x 2" With Washer Stainless Steel

part # 95513154961



NAILS, DRIVE PINS, & ANCHORS

1" Masonry Galvanized Steel

5 lb. - part # 531412910



1 1/2" Masonry Galvanized Steel

5 lb. - part # 531432910



#10 1/4" Plastic Anchor

100 ct. - part # 541210099



TOUCH-UP PAINT

Packaged 12 Units/Box

Brush-On Paint, 0.6 oz.

part # 581006XXX



Available in: 26 Traditional,
1 Duel Tone®, 3 Armor Tough®

Spray-On Paint, 12 oz.

part # 582160XXX



Available in: 26 Traditional, 3 Armor Tough®

SEALANT - NITRILE RUBBER BASE

Packaged 24 Units/Box

Rusco PSCG, 1/10 Gallon

part # 591141014



Rusco PSCG-HV, 1/10 Gallon

part # 591142014



SEALANT - TRIPOLYMER BASE

Packaged 24 Units/Box

Geocel 2320, 1/10 Gallon

part # 593320XXX



Available in: White, Gray, Clear

Geocel 2321, 5 oz. Tube

part # 593321001



Available in: White

SEALANT - SBR RUBBER BASE

Packaged 24 Units/Box

OSI GS121, 1/10 Gallon

part # 592121001



Available in: White

AVIATION SNIPS

Max 2000, Left
part # 891M2001



Max 2000, Right
part # 891M2002



Max 2000, Straight
part # 891M2003



OFFSET SNIPS

Max 2000, Left
part # 891M2006



Max 2000, Right
part # 891M2007



REGULAR PATTERN SNIPS

Regular Pattern Snips, 9"
part # 891M9



STRAIGHT SNIPS

Straight Snips, 12"
part # 891M12N
part # 891M12A



Straight Snips, 14"
part # 891M14N
part # 891M14A



CIRCULAR "DUCKBILL" SNIPS

Circular "Duckbill" Snips, 10"
part # 891MD10

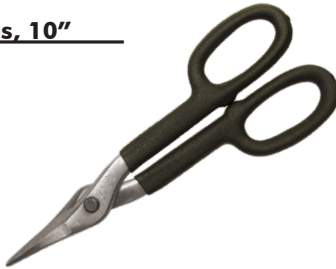

Circular "Duckbill" Snips, 12"
part # 891MD12



COMBINATION SNIPS

Combination Snips, 12"
part # 891MC12N
part # 891MC12A



Replacement Blade
part # 891MC12NRB
part # 891MC12ARB

Combination Snips, 14"
part # 891MC14N
part # 891MC14A



Replacement Blade
part # 891MC14NRB
part # 891MC14ARB

END CAP CRIMPERS

Snap Lock Punch
part # 894SL1R



Adjustable Snap Lock Punch
part # 894SL2R



DOWNSPOUT CRIMPERS

Single Blade

part # 894SC1

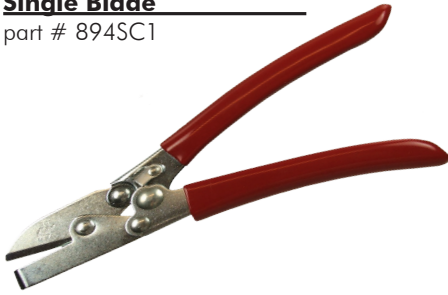

3-Blade

part # 894SC3R



5-Blade

part # 894C4R



HAND SEAMERS

3"

part # 894S2R



Offset, 3"

part # 894S3R



6"

part # 894S6R



Tool Replacement Spring

part # 8945018



DRIVERS & LEVELING

Magnetic Bit Holder, 1/4"

part # 895MBH14



Nut Driver Extension, 6"

part # 895BHE6



Nut Driver, 1/4"

1 3/4" - part # 895MSH14

2 9/16" - part # 895MSHL14

4" - part # 895MSHML14

Malco 6" - part # 895MSHXL14

8" - part # 895MSHL148



Torpedo Level, 9"

part # 898L9



Hand Riveter, Economy

part # 896CR18



Vampire T-Bar Tool

part # 89717232



Caulking Gun

part # 898CG10



CUTTING & DRILLING

Hole Saw Pilot Bit

part # 892HSB



Hole Saw 2 3/8"

part # 892H38



Hole Saw 2 3/4"

part # 892H44



ProTouch Combi-Saw

part # 892218HP300



12" 32 TPI Hacksaw Blade

part # 89220146V232HE



Saw Blade Lubricant Stick

part # 899LUBS



#30 Double Ended Bit 1/8"

part # 896NDE30



Grease Crayon, White, .43 oz.

part # 899WLB2



LADDER ACCESSORIES

Ladder Max

part # 898162100



Ladder Guards

part # 898165510



Ladder Max Multi-Pro

part # 898162110

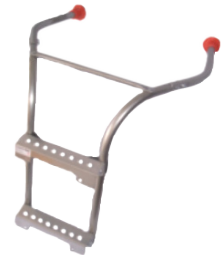

MISCELLANEOUS ACCESSORIES

Wasp Spray, 20 oz.

part # 899WASP



Trough Mate

part # 898TM614



Extension Cord, 50', 10 ga.

part # 898ECORD50



JOINTS

Expansion Joints for K-Style 5", 6"

1 unit/box

5" - part # 293305099

6" - part # 293306099

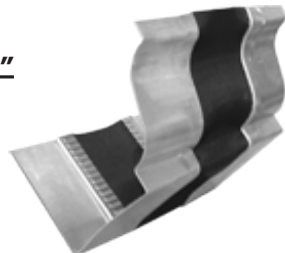

Available in: Aluminum

RAIN CHAINS

Hammered Cup

Green Patina Copper

part # 494021885

Available in: Solid Copper



SOLID COPPER

Hammered Cup

Painted Aluminum

part # 494021XXX

Available: in Black (004), Dark Bronze (025)



BLACK



DARK BRONZE

Gutter Reducer Adaptor

Copper

part # ON494111890

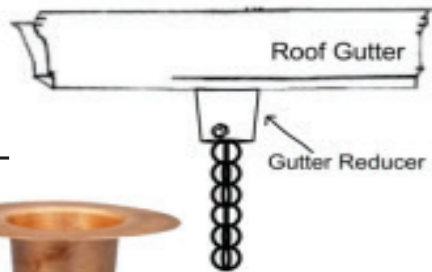

Gutter Reducer Adaptor

Aluminum

part # 494111099

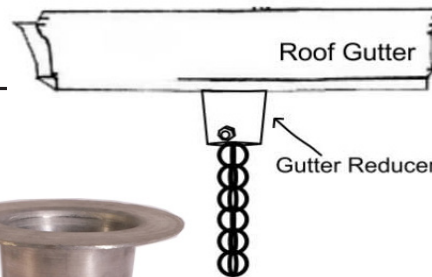

CONDUCTOR HEADS

Packaged 1 Unit/Box

Senox conductor heads are available in a wide variety of sizes and colors, to perfectly finish the job with no modifications needed.

Plain

2" x 3" & 3" x 4" Rectangle Outlet

2" x 3" - part # 441005XXX

3" x 4" - part # 441006XXX

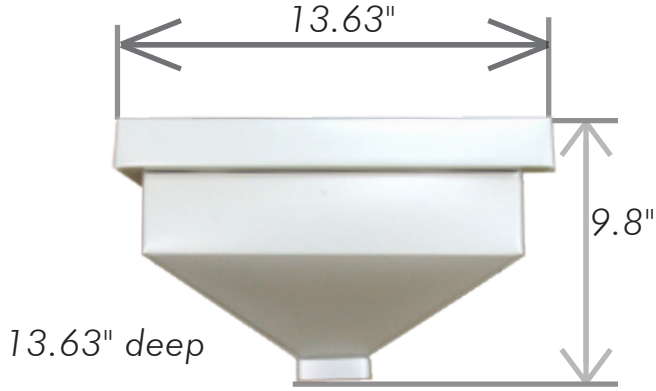

Available in: 30° White (001), 16 oz. Solid Copper (890), 26 ga. Galvalume Plus Steel (920)

Decorative

3" & 4" Oval Outlet

3" - part # 441201XXX

4" - part # 441203XXX

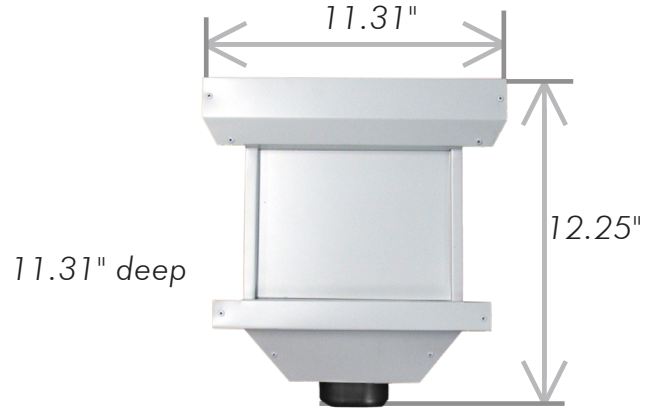

Available in: 26 Traditional, 1 Duel Tone® (129), 3 Armor Tough®, 16 oz. Solid Copper (890), 26 ga. Galvalume Plus Steel (920)

Ornamental

3" & 4" Round Outlet

3" - part # 442008XXX

4" - part # 442009XXX

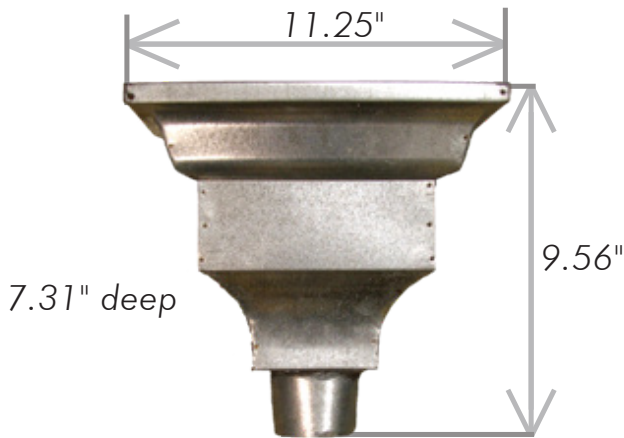

Available in: 16 oz. Solid Copper (890), 26 ga. Galv Steel (920)

Basic

4" Round Outlet

part # 441603001

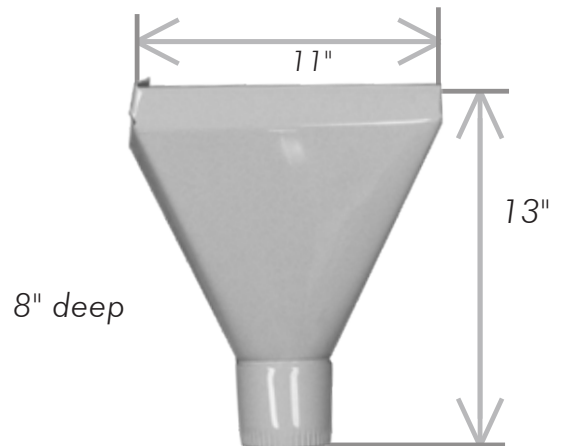

Available in: 30° White

SENOX BARRACUDA® GUTTER MACHINES

A quality gutter machine is the cornerstone of all successful gutter businesses, and it is incredibly important to make sure you have a reliable machine that will do exactly what you need to satisfy your customers. Contact your Senox representative before purchasing to help match you with the perfect machine for you.

5" K-Style
6' 9" x 2' x 4'
part # 81112001501

5"/6" Combo K-Style
9' x 2' x 4'
part # 81112001511

6" K-Style
9' x 2' x 4'
part # 81112001601

6"/7" Combo K-Style
12' 7" x 2' x 4'
part # 81112001621

7" K-Style
12' 7" x 2' x 4'
part # 81112001701

6" Reverse Bead Half Round
14' x 2' x 4'
part # 81112016601



*Cradle not included with base machine

SENOX BARRACUDA® GUTTER MACHINE OPTIONS

Everything you need to get the most out of your Barracuda® gutter machine.

Front Pull Guillotine

5" & 5"/6" Combo
part # 8111300151

7" & 6"/7" Combo
part # 8111300172

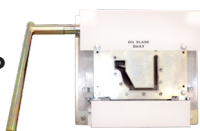

6" & 5"/6" Combo
part # 8111300161

6" Half Round
part # 8111301660

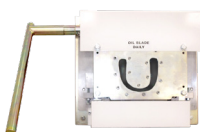

6" & 6"/7" Combo
part # 8111300162

End Plate (No Shear)

5" & 6" & 5"/6" Combo
part # 8111350151

7" & 6"/7" Combo
part # 8111350172



Full Coil Cradle Machine Mount

5" & 6" | 5"/6" Combo | 6"HR
part # 811140151

7" | 6"/7" Combo
part # 811140172

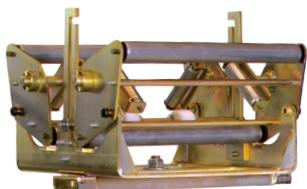

Spin Coil Cradle Machine Mount

w/Single Scuff Bar & Side Roller Assembly
part # 811145151

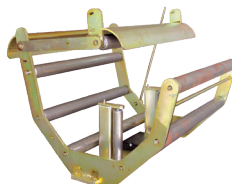

Side Roller Assembly For Cradle

part # 81904505



Spool w/ Shaft

5" & 6" & 5"/6" Combo, 6" HR
part # 811160151

7" & 6"/7" Combo
part # 811160172

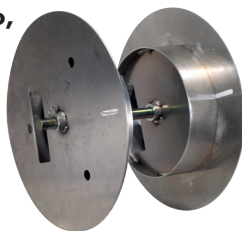

Upright Turnstile

5" & 6" | 5"/6" Combo | 6"HR
part # 811150151

7" & 6"/7" Combo
part # 811150172



Transfer Bar Set

Fits All Sizes

part # 811165001

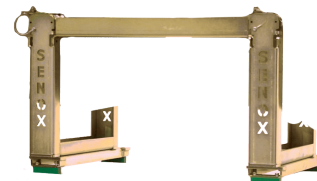

Standard Run Out Stand w/ Adjustable Leg

5" & 6" & 5"/6" Combo, 6" HR
part # 811180100

7" & 6"/7" Combo
part # 811180107



Deluxe Run Out Stand w/ Adjustable Leg

5" & 6" & 5"/6" Combo, 6" HR
part # 811180130



Machine Stand Riser Pad, Tall Fits All Machines

part # 811190001



SENOX[®]

LICENSED PRODUCTS



5/6 Boxer

Depth: 20.02"
 Width: 30.37"
 Length: 124.24"
 Weight: 1200 lbs (base machine)



6.5 Half Round Wedger

Depth: 19"
 Width: 24"
 Length: 161"
 Weight: 1574 lbs (base machine)



AQUEDUCT INSTALLATION TOOL

Installation Tool, 5"

part #8L354005

Installation Tool, 6"

part #8L354006

Installation Tool, 7"

part #8L354007

Installation Tool, 6.5"

part #8L354065

AQUEDUCT HANGERS

For 5", 6", 6.5", and 7"

25 pcs/box

Screen Hanger, 5" x 4' - part # 3540050XXX

Screen Hanger, 6" x 4' - part # 3540060XXX

Screen Hanger, 7" x 4' - part # 3540070XXX

Screen Hanger, 6.5" x 4' - part # 3540650XXX

AQUEDUCT MITERS

For 5", 6", and 6.5"

20 pcs/box

Strip, 5", 90°, O/S & I/S- part # 334011961

Strip, 6", 90°, O/S & I/S- part # 334311961

Strip, 6.5", 90°, O/S & I/S- part # 334511961

Strip, 5", 45°, O/S & I/S- part # 334031961

Strip, 6", 45°, O/S & I/S- part # 334331961

Strip, 6.5", 45°, O/S & I/S- part # 334531961

BEARCLAW HANGERS

For 5", 6", for 6.5" HR

100 pcs/box - Aluminum

5", no clip, with screw - part # 3455501099

6", no clip, with screw - part # 3455601099

6.5" HR, with screw - part # 3455651099

BEARCLAW GUTTER GUARD

For 5", 6", and 6.5"

25 pcs/box

BearCLAW Expanded 5" x 4'- part # 383105XXX

BearCLAW Expanded 6" x 4'- part # 383106XXX

BearCLAW Expanded 6.5" x 4' HR-part # 383166XXX

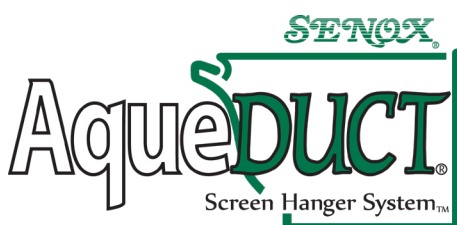

Available In:

5/6 Boxer
 6.5 Half Round Wedger



Contact Clint Morgan 800-973-3102 for more information on Licensed Products

1. The front lip and associated hangers are available in K-Style (K-STYLE), Pocket Lock Lip (PLL), and Reverse Bead Half Round (RBHR).

2. The face and bottom are available in OG (OG), Flat Face (FF), and Half Round (HR).

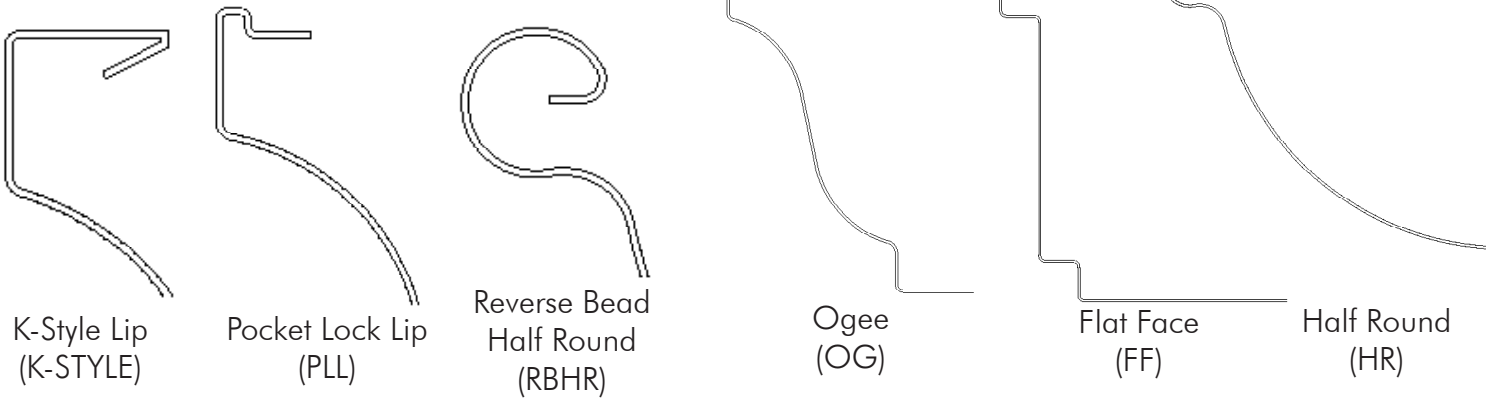

3. The back and gutter bumpers are available in Straight Back (SB), Straight Back High/Low (SBHL), Half Round Reverse Bead (HR), Half Round Wedger (HW), and Half Round High Back (HH).

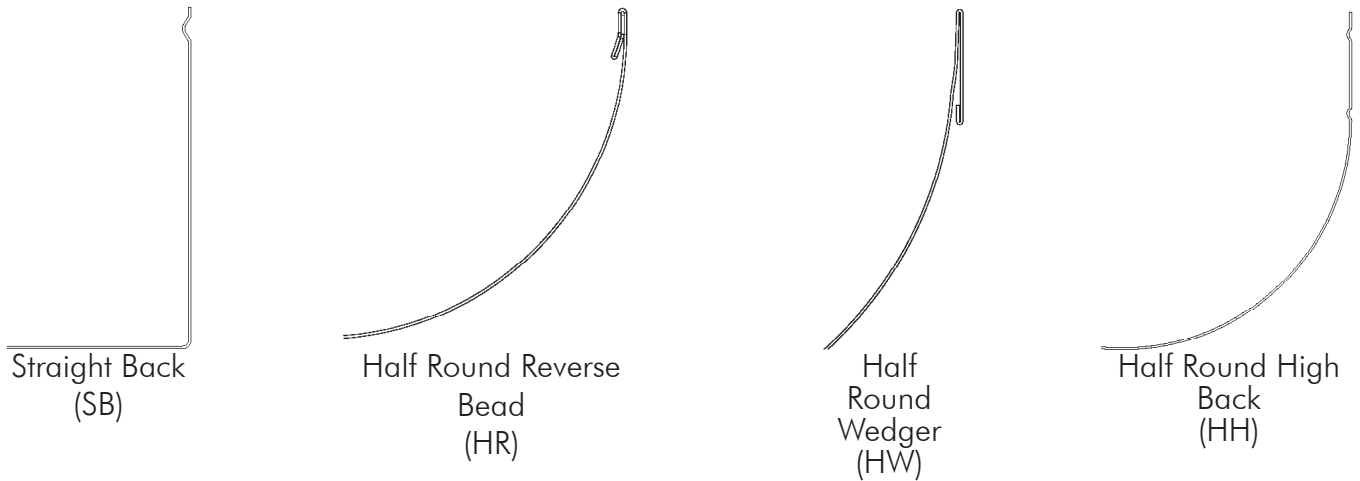

4. Gutterguards are available in K-Style, BearCLAW, AqueDUCT, and LeafLID.

The major discrepancy in everyone's mind is centered around OG vs. K-Style. Our opinion is OG speaks to the shape of the gutter face. This shape has been around since the Greeks. K-Style describes the hanger style and front lip design on the top of the OG shape. Over time the K-Style front lip and the OG shape have become synonymous in people's minds. Because of the new styles of front lips and hangers, this thinking needs to be separated to allow us to describe them separately. Our additional designs for the back of the gutter also call for more precise definitions.

—A.B. Walters
President

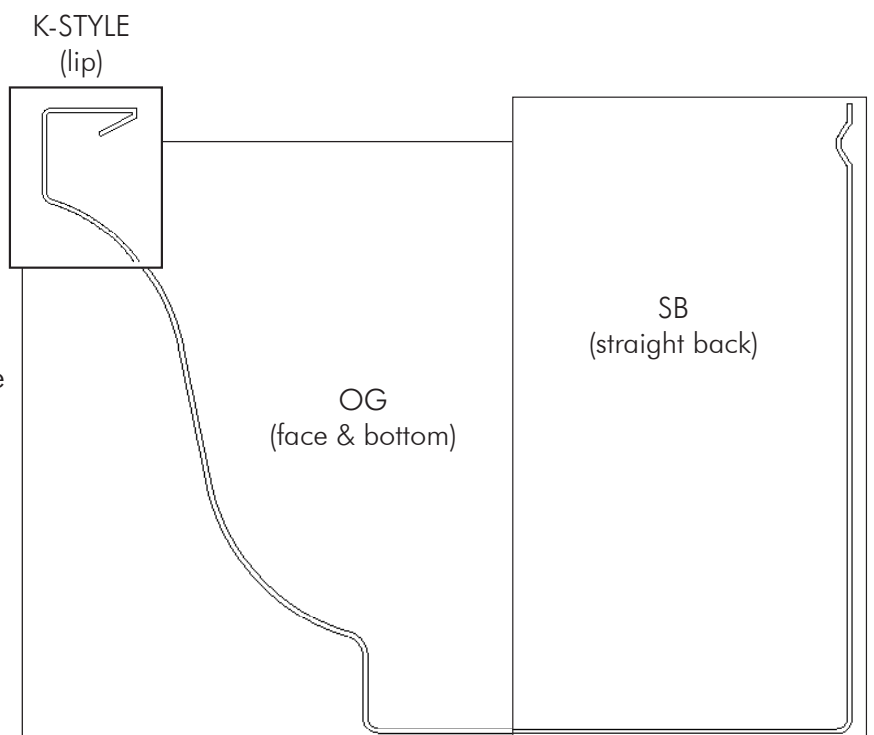

- A**
 Accessories, Downspout8
 Accessories, Ladder21
 Accessories, Miscellaneous21
 Adaptors, Underground Drainage16
 Anchors, Nails, & Drive Pins17
 Aviation Snips19
- B**
 Bar w/ Rod for 6"13
 Barracuda Gutter Machines, Senox24
 Barracuda Gutter Machine Options, Senox24
 Black MAX Punch Pak Flat Bottom Gutter5
 Black MAX Mini Punch Pak Flat Bottom Gutter5
 Black MAX Mini Punch Pak Half Round13
 Black MAX Punch Replacement Accessories5
 Blade, Hacksaw21
 Bracket, 6" Cast23
 Bolt w/ Nut12
- C**
 Cast Bracket, 6"23
 Caulking, Drivers, & Leveling20
 Circular "Duckbill" Snips19
 Coil, Seamless Gutter4
 Combination Snips19
 Combi-Saw21
 Conductor Heads23
 Copper Flat Sheets, Solid6
 Crimpers, Downspout20
 Crimpers, End Cap20
 Cutting & Drilling21
- D**
 Downspout Accessories9
 Downspout Crimpers20
 Downspout Hangers9
 Downspouts, Rectangular7
 Downspouts, Round8
 Drainage & Adaptors16
 Drilling & Cutting21
 Drip Cap6
 Drip Edge6
 Drive Pins, Anchors, & Nails17
 Drivers, Leveling, & Caulking20
 Duckbill Snips, Circular19
- E**
 Elbows, Rectangular7
 Elbows, Round8
 End Cap Crimpers19
 End Caps for Half Round13
 End Caps for K-Style4
 Expansion Joints for K-Style21
 Extension Cord21
 External Hangers, Half Round12
- F**
 Flashing6
 Flat Sheets, Solid Copper6
 FLEX-Drain Underground Drainage & Adaptors16
- G**
 Grease Crayon21
 Gutter Bumper HR13
 Gutter Bumper SB6
 Gutter Coil, Seamless4
 Gutter Guard, Aluminum Expanded Wire14
 Gutter Guard, Louvered15
 Gutter Guard, Perforated14
 Gutter Guard, Powder Coated Expanded Wire14
 Gutter Guard, Solid15
 Gutter Guard, Stainless Steel Metal Mesh15
 Gutter Machine Options, Senox Barracuda24
 Gutter Machines, Senox Barracuda24
 Gutter Machines, Senox Licensed Products25
 Gutter Sections, Reverse Bead Half Round13
 Gutter Wedges for Reverse Bead Half Round13
- H**
 Hacksaw Blade21
 Half Round External Hangers12
 Half Round Gutter Sections, Reverse Bead13
 Half Round Internal Hangers, Reverse Bead12
 Half Round Miters13
 Half Round Outlets13
 Hand Riveters20
 Hand Seamers20
 Hangers, Downspout9
 Hangers, K-Style Internal10-11
 Hangers, Reverse Bead Half Round Internal12
 Hangers, Half Round External12
 Hole Saw 1^{1/2}", for Punch5
 Hole Saw21
- I**
 Internal Hangers, Reverse Bead Half Round12
 Internal Hangers, K-Style10-11
- J**
 Joints21
- K**
 K-Style Internal Hangers10-11
- L**
 Ladder Accessories21
 Leveling, Caulking, & Drivers20
 Licensed Products, Gutter Machines25
 Lubricant, Saw Blade21
- M**
 Mini Punch Pak Flat Bottom Gutter, Black Max5
 Mini Punch Pak Half Round, Black Max13
 Miscellaneous Accessories21
 Miters for Half Round13
 Miters for K-Style4
- N**
 Nails, Drive Pins, & Anchors17
- O**
 Offsets, Rectangular7
 Offsets, Round8
 Offset Snips19
 OSI Sealant18
 Outlets for Flat Bottom Gutter5
 Outlets for Half Round13
- P**
 Paint, Touch-Up18
 Pipe Bands, Downspout Hangers9
 Punch Pak Flat Bottom Gutter, Black MAX5
 Punch Pak Flat Bottom Gutter, Black MAX Mini5
 Punch Pak Half Round, Black MAX Mini13
 Punch Replacement Accessories, Black MAX5
- R**
 Rain Chains22
 Rectangular Downspouts7
 Rectangular Elbows7
 Rectangular Offsets7
 Regular Pattern Snips19
 Reverse Bead Half Round Gutter Sections13
 Reverse Bead Half Round Internal Hangers12
 Rivets, #42 x 1/8"17
 Round Downspouts8
 Round Elbows8
 Round Offsets8
 Ruscoe Sealants18
- S**
 Saw Blade Lubricant21
 Screws, #817
 Screws, SpeedMaster®17
 Sealant, Nitrile Rubber Base18
 Sealant, SBR Rubber Base18
 Sealant, Tripolymer Base18
 Seamers, Hand20
 Seamless Gutter Coil4
 Snips19
 Solid Copper Flat Sheets6
 Splash Blocks16
 Straight Snips19
 Stamped Bracket, 5800 Series12
- T**
 Touch-Up Paint18
 T-Strap, 9000 Series11
 Torpedo Level20
 Trough Mate21
- U**
 Underground Drainage & Adaptors16
- W**
 Wedges for Reverse Bead Half Round, Gutter13
 Wrap Around w/Strap13



Serving the Seamless Gutter Industry Since 1972

15409 Long Vista Drive
Austin, TX 78728

Phone: 866-522-1696
Fax: 800-295-2702

www.senox.com
senoxinfo@senox.com